

1

Bolero 1 Bolero 2

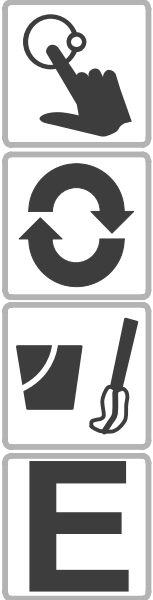





User manual
Mode d'emploi Utilisateur
Gebraucher Handbuch
Gebruiksaanwijzing
Användarmanualen
Brukerhåndbok
Brugsanvisningen
Käyttäjän käsikirja
Manual del usuario
Manual do utilizador
Manuale per l'utente
Εγχειρίδιο χρήσης
Prostudujte uživatelskou
Podręcznik użytkownika
Manualul utilizatorului
уководство пользователя
Kullanıcı kılavuzu
使用者手冊
ユーザーマニュアル
사용자 설명서











English
Français
Deutsch
Nederlands
Svenska



Norsk
Dansk
Suomi
Español
Português

Information Information Information Informatie Information		Informasjon Information Informaatio Información Informação
Table of contents Table des matières Inhaltsangabe Inhoudsopgave Innehållsförteckning		Innholdsfortegnelse Indholdsfortegnelse Sisällysluettelo Contenido Índice
Handling Fonctionnement Bedienung Bedienen Handhavande		Betjene Betjening Käsittely Operación Execução
Selection button Touches de sélection Wahltaste Keuzetoets Väljarknapp		Velgerknapp Valg knap Valintanappi Tecla de selección Botão de selecção
Water Eau Wasser Water Vatten		Vann Vand Vesi Água Água

Fill / empty Remplissage / vidange Füllen / Entleeren Vullen / legen Påfyllning / tömning		Fyll / Tom Fuld / Tom Täyttö / tyhjennys Llenar / vaciar Cheio / vazio
Cleaning Nettoyage Reinigung Schoonmaken Rengöring		Vasking Rengøring Puhdistus Limpiar Limpeza
Cleaning, daily Nettoyage quotidien Reinigung, täglich Schoonmaken, dagelijks Daglig rengöring		Daglig vask Rengøring, daglig Päivittäinen puhdistus Limpieza diaria Limpeza diária
Cleaning, weekly Nettoyage hebdomadaire Reinigung, wöchentlich Schoonmaken, wekelijks Vecko rengöring		Ukentlig vask Rengøring, ugentlig Viikoittainen puhdistus Limpieza semanal Limpeza semanal
Canister Bac produit Kanister Canister Kanister		Kanister Beholder Kanisteri Contenedor de producto Depósito
Mixing system Mélangeur Mischsystem Mixsystem Blandnings system		Miksesystem Mixer system Sekoitusjärjestelmä Sistema de mezclar Sistema de mistura
Ventilation system Système de ventilation Abluftsystem Ventilatiesysteem Ventilationssystem		Viftesystem Ventilationssystem Ilmastointijärjestelmä Sistema de ventilación Sistema de ventilação
Drip-tray Egouttoir Tropfschale Lekbak Spillbricka		Spillbrett Drypbakke Tippa-allas Escurridero Tabuleiro
Messages Messages Meldungen Meldingen Meddelanden		Meldinger Beskeder Viestit Mensajes Mensagens









it : Per la Sua lingua consultare la fine di questo documento.
 el : Στην αναδιπλωμένη σελίδα, στο τέλος του εντύπου, μπορείτε να κοιτάξετε για τους όρους στη γλώσσα σας.
 cz : Volba jazyka je popsána na konci následující stránky tohoto návodu.
 pl : Szukaj swojego języka na ostatnich stronach dokumentu.
 ro : Citiți pentru limba dvs pagina atașată la spatele acestui document.
 ru : Вкладыш на Вашем языке в конце этого документа.
 tr : Diliniz için arkadaki katlı sayfaya bakınız.
 ch : 查看背頁的所屬語文
 jp : 各言語についてはこの説明書の最後のページをご参照ください。
 kor : 자료의 뒷면 접은 페이지에서 해당 언어를 참조 하시오



English
Français
Deutsch
Nederlands
Svenska



Norsk
Dansk
Suomi
Español
Português

Safety book Sommaire des sécurités Sicherheitsvorschriften Veiligheidsboek Säkerhetsföreskrifter	 700.403.347	Sikkerhetsbok Sikkerhedsbog Turvallisuusohjeet Libro de seguridad Instruções de segurança
Operator manual Mode d'emploi Opérateur Operator Handbuch Operator handleiding Driftmanual	 700.403.565	Operatørhåndbok Betjeningsvejledning Operaattorin käsikirja Manual del operador Manual do operador
List of ingredients Liste des ingrédients Produktliste Ingrediëntenblad Ingredienslista		Ingrediensliste Ingrediens liste Ainesosaluettelo Lista de ingredientes Lista de ingredientes
Wait Patienter Warten Wachten Vänta		Vent Vent Odota Esperar Aguardar
Brush Brosse Pinsel Kwast / Borstel Borste		Kost Børste Harjaa Sepillar Escova
Moist cloth Chiffon humide Feuchtes Tuch Vochtige doek Fuktig trasa		Fuktig klud Fugtig klud Kostea pyyhe Trapo húmedo Pano húmido
Rinse Rincer Spülen Afspoelen Sköljning		Skylle Rensning Huuhtelee Aclarar Enxaguamento
Detergent Détergent Spülmittel Afwasmiddel Rengöringsmedel		Vaskemiddel Rengöringsmiddel Puhdistusaine Detergente Detergente
Dishwasher proof Lave-vaisselle autorisé Geschirrspülertauglich Vaatwasmaschine bestandig Tål maskindisk		Tåler oppvaskmaskin Maskinopvaske bestandig Astianpesukoneen kestävä Rest. para lavaplatos À prova de máquina de lavar louça

Energy-saving mode Mode économique Energiesparen Energiesparend Energisparläge		Energisparing Energispare funktion Sähköä säästävä Posición economía Modo de economía de energía
Call distributor Appelez votre distributeur Händler anrufen Verkoopkantoor bellen Ring Leverantör		Ring leverandör Tilkald forhandler Soita jälleenmyyjälle Llame al distribuidor Contacto importador
Descaling Détartrage Entkalkung Ontkalken Avkalkning		Rensing Afkalkning Kalkinpoisto Descalcificación Descalcificação



Handling
Fonctionnement
Bedienung
Bedienen
Handhavande

Betjene
Betjening
Käsittely
Operación
Execução

Istruzione d'uso
Χειρισμός
Obsluha
Instrukcja obsługi
Instalare

Обслуживание
Kullanım
操作
取り扱い
취급

1



Fill / empty
Remplissage /
vidange
Füllen / Entleeren
Vullen / legen
Påfyllning / tömning

Fyll / Tøm
Fuld / Tom
Täyttö / tyhjennys
Llenar / vaciar
Cheio / vazio

Riempire / scaricare
Ενδειξη γεμάτο /
Άδειο
Plný / prázdny
Pełny / pusty
Plin / Gol

Наполнить /
опорожнить
Doldurma / Boşaltma
滿/空
給水・空にする
채움/텅빈

3



4



Cleaning
Nettoyage
Reinigung
Schoonmaken
Rengöring

Vasking
Rengöring
Puhdistus
Limpiar
Limpeza

Pulizia
Καθαρισμός
Čištění
Czyszczenie
Curaçare

уистка
Temizleme
清洗
洗淨
청소

9



10



16



18



22



Messages
Messages
Meldungen
Meldingen
Meddelanden

Meldinger
Beskeder
Viestit
Mensajes
Mensagens

Messaggio
Μηνύματα
Zprávy
Wiadomości
Mesaje

Сообщения
Mesajlar
信息
メッセージ
메세지

25



Handling
Fonctionnement
Bedienung
Bedienen
Handhavande

Betjene
Betjening
Käsittely
Operación
Execução

Istruzione d'uso
Χειρισμός
Obsluha
Instrukcja obsługi
Instalare

Обслуживание
Kullanım
操作
取り扱い
취급

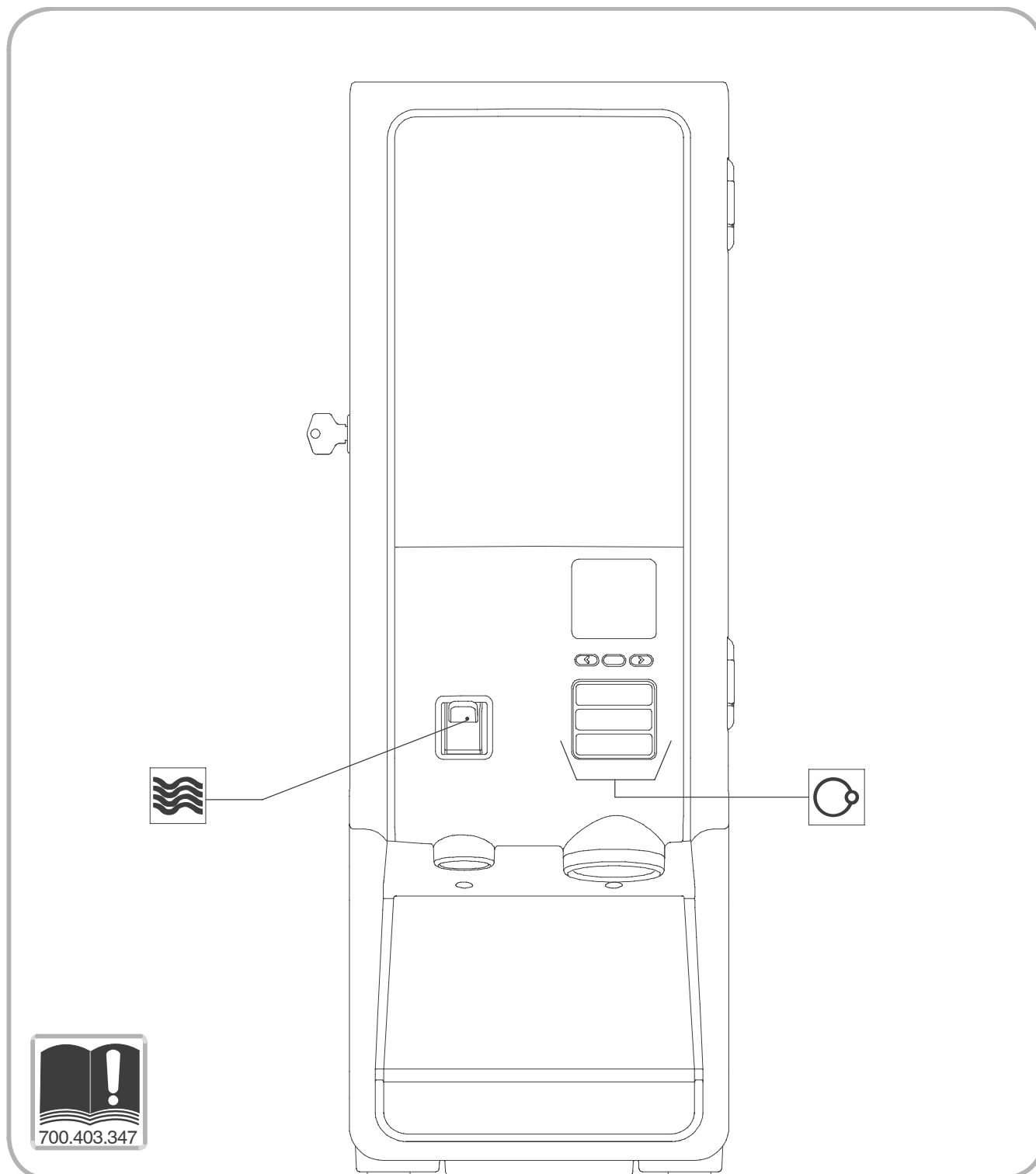



Bolero 1

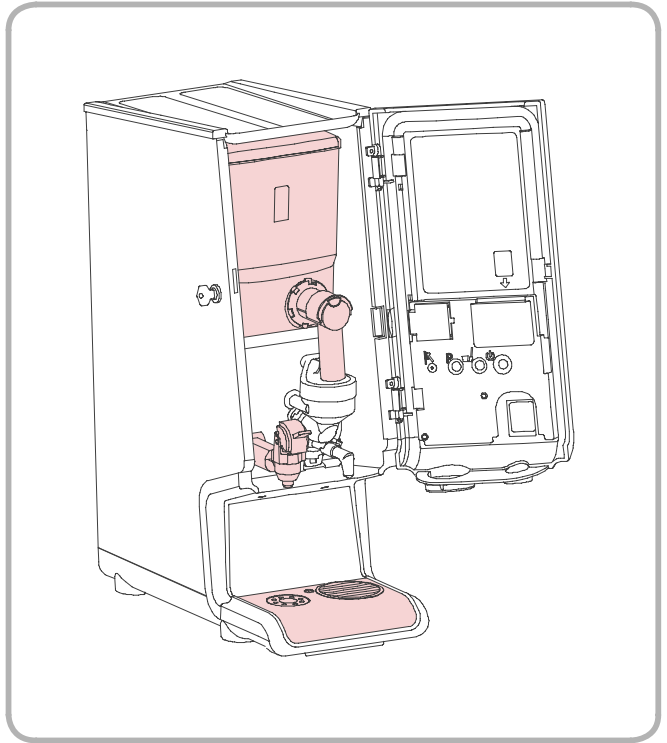
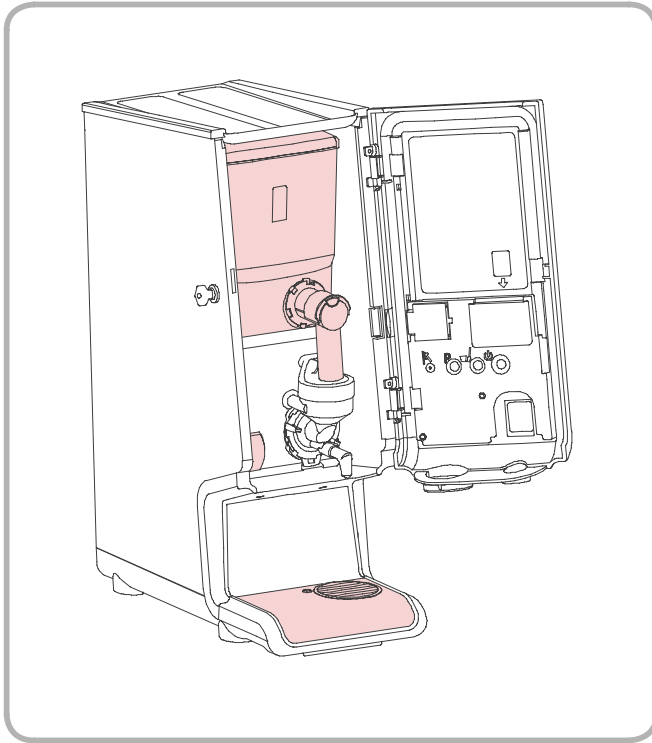

Bolero 2

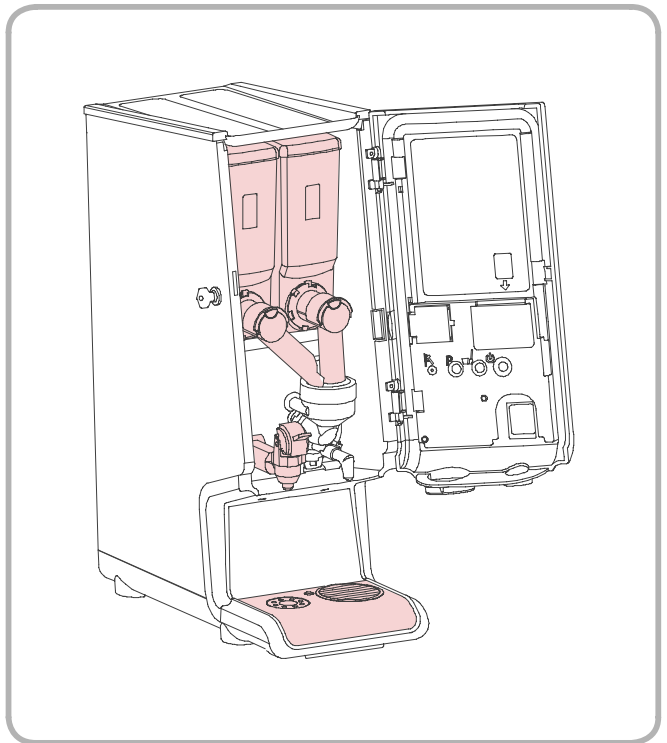
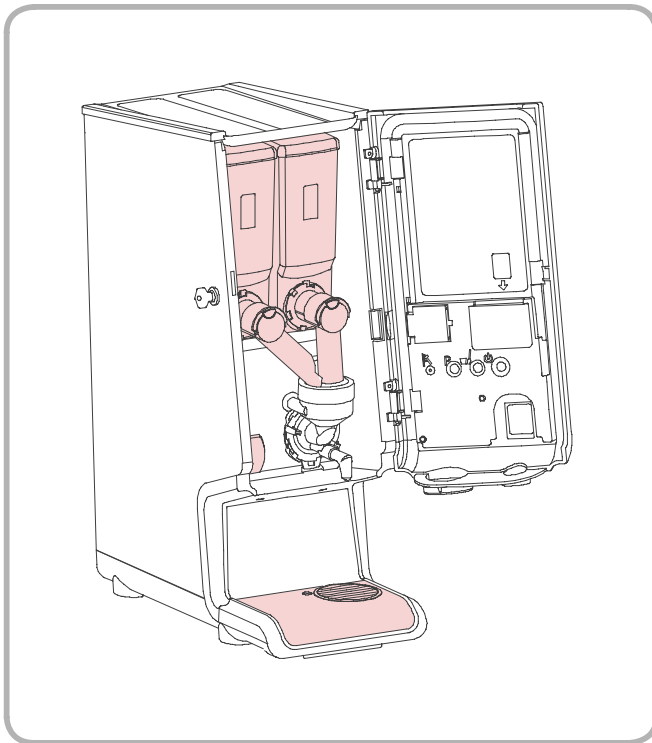



Fill / empty
Remplissage /
vidange
Füllen / Entleeren
Vullen / legen
Påfyllning / tömning

Fyll / Tøm
Fuld / Tom
Täyttö / tyhjennys
lenar / vaciar
Cheio / vazio

Riempire / scaricare
Ενδειξη γεμάτο / Άδειο
Plný / prázdny
Pełny / pusty
Plin / Gol

Наполнить /
опорожнить
Doldurma /
Boşaltma
満/空
給水・空にする
채움/텅빈

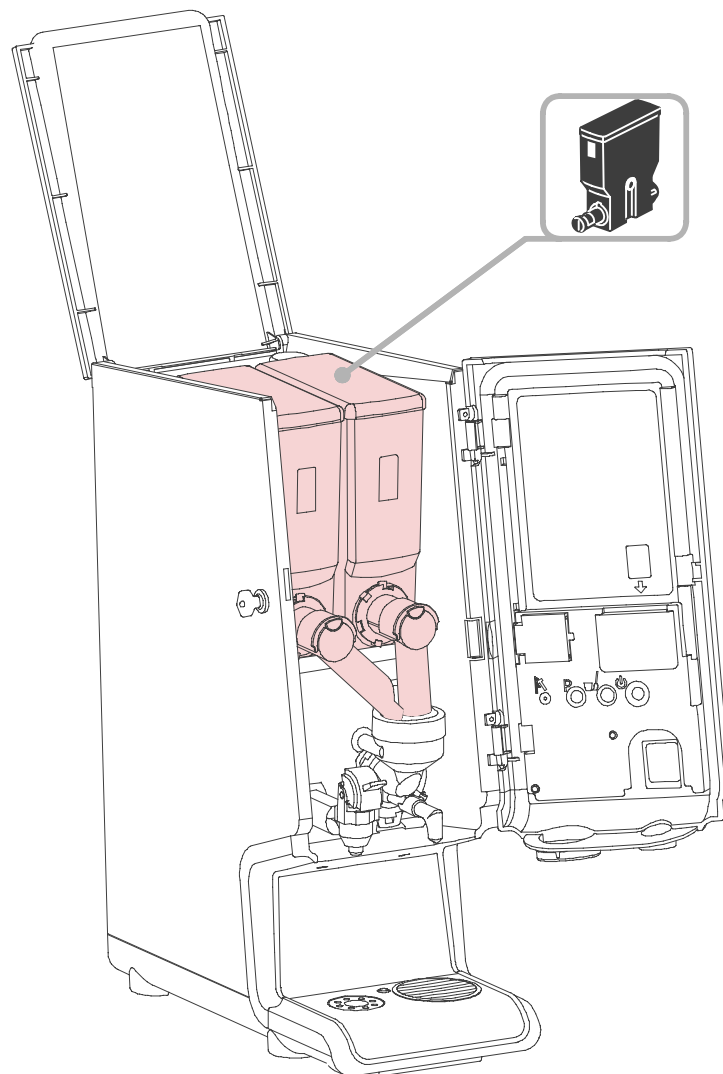

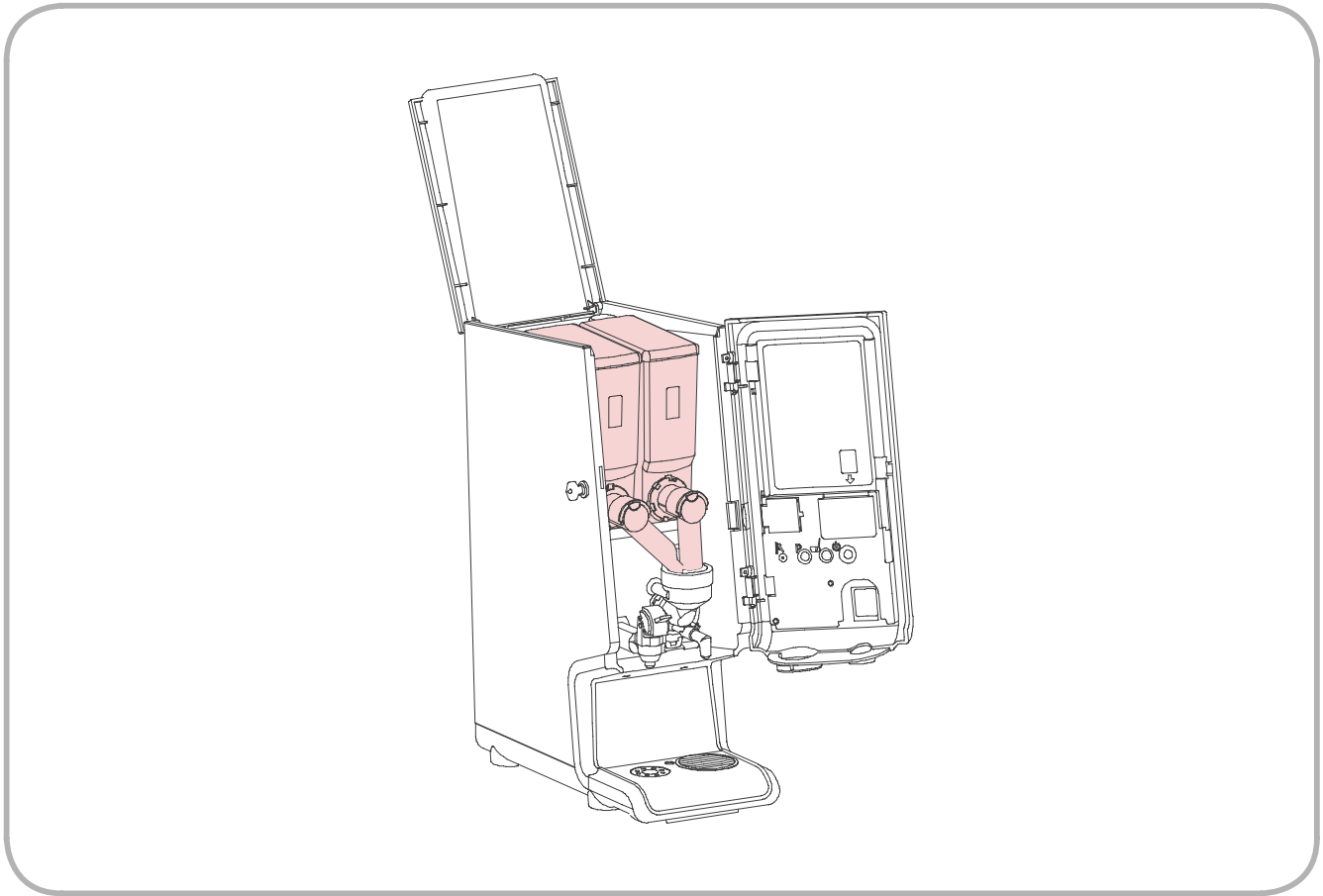
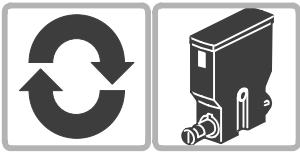

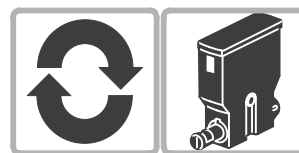

1.

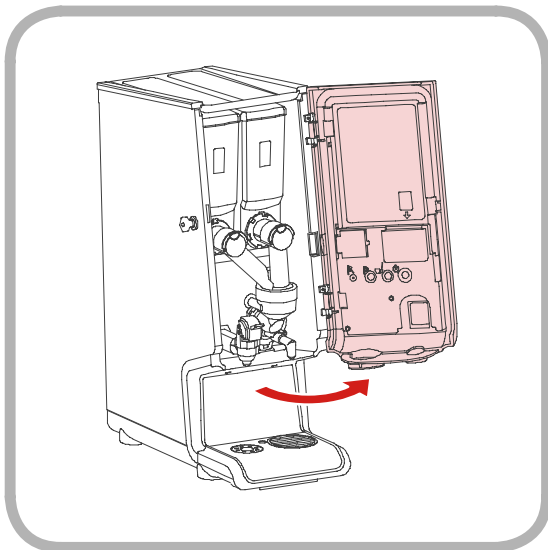

2.

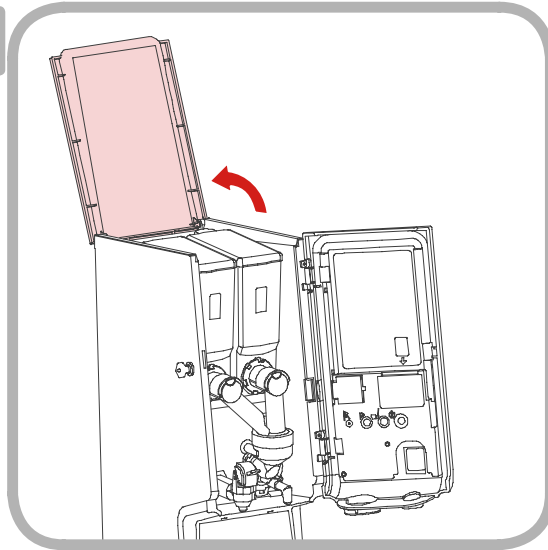

3.

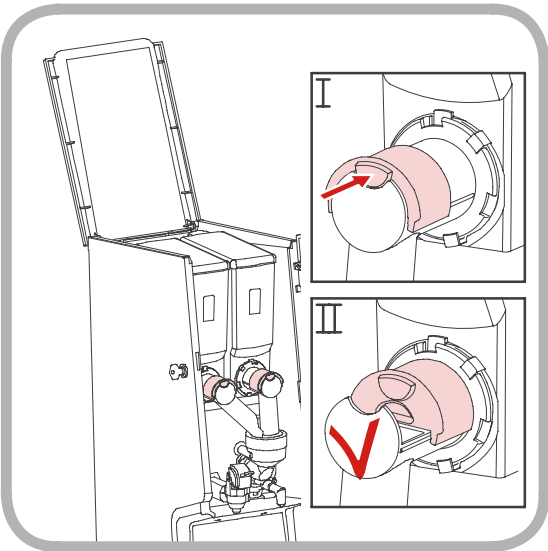

4.

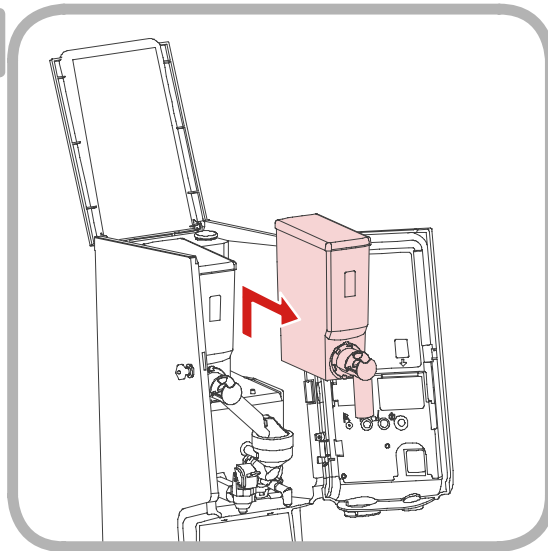

5.

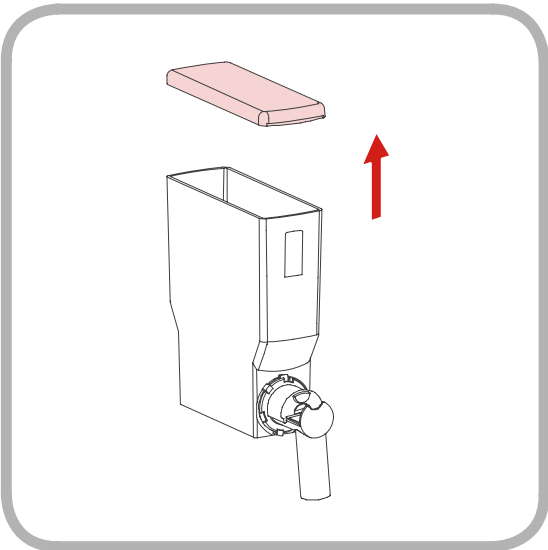

6.

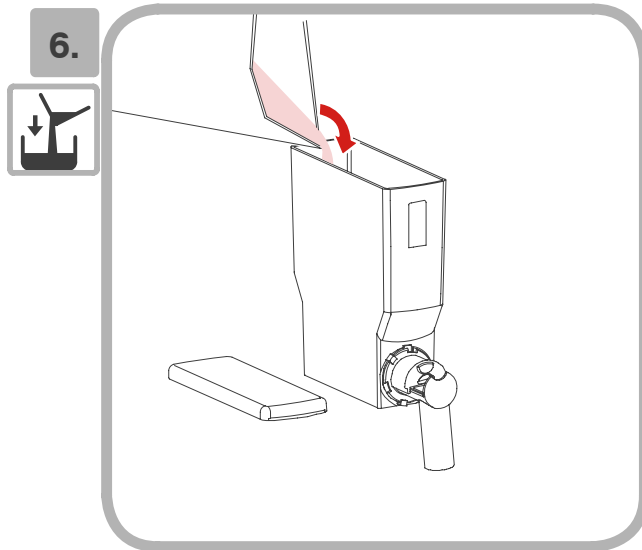

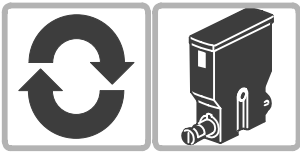

7.

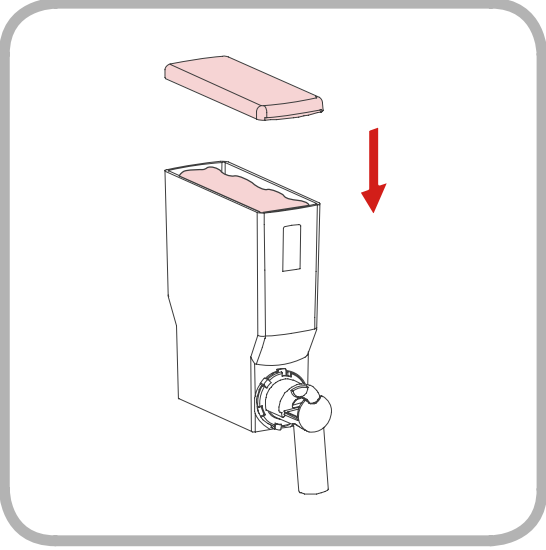

8.

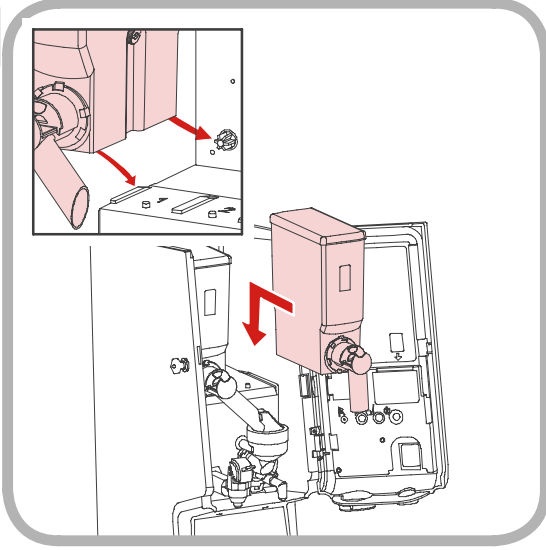

9.

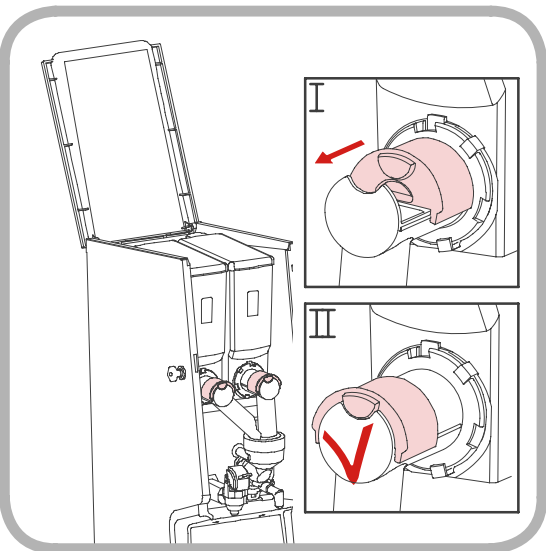

10.

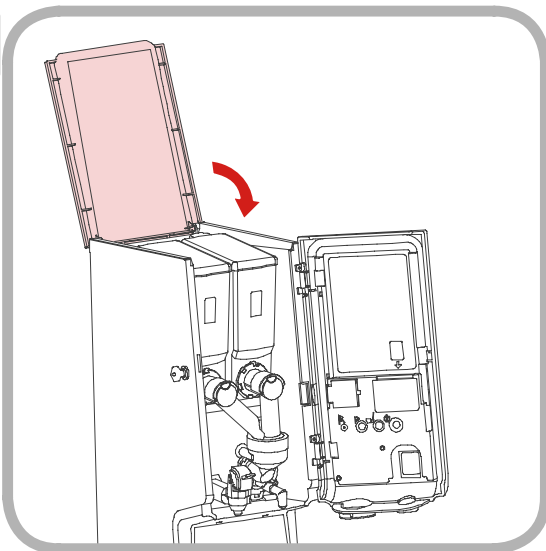

11.

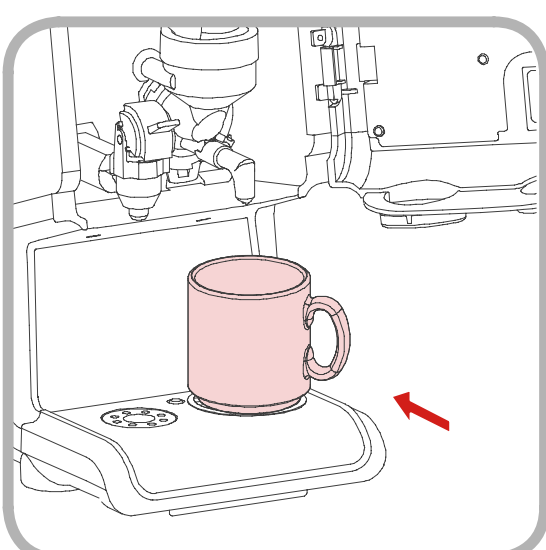

12.

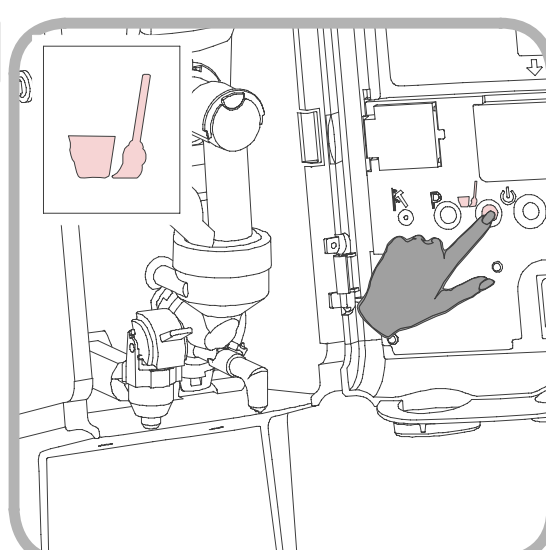

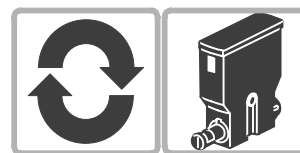

13.

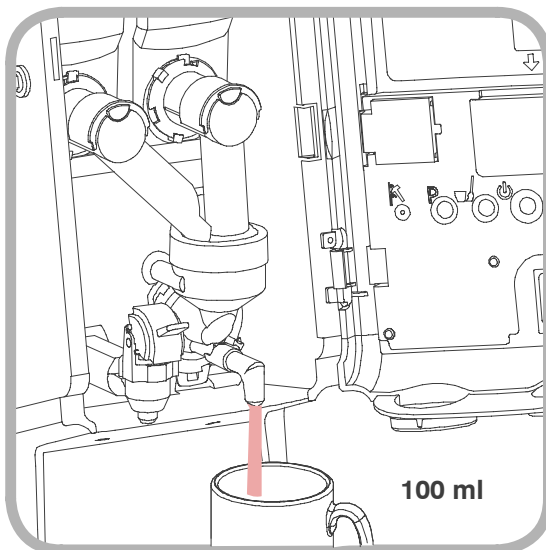

14.

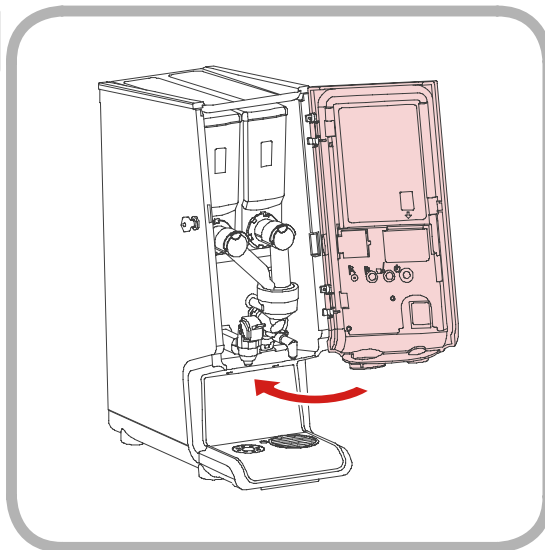

15.

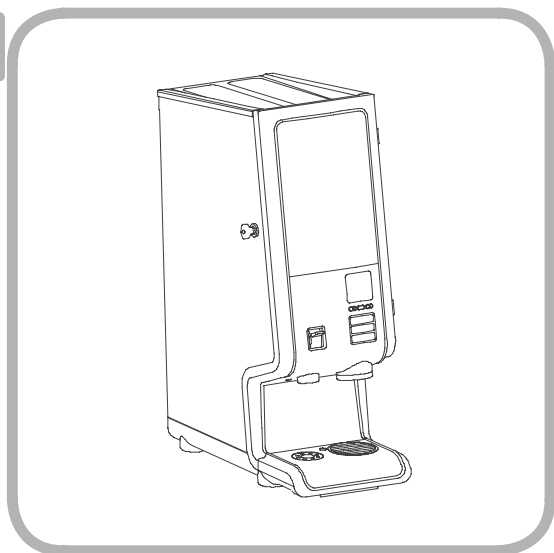



Cleaning
Nettoyage
Reinigung
Schoonmaken
Rengöring

Vasking
Rengøring
Puhdistus
Limpiar
Limpeza

Pulizia
Καθαρισμός
Čištění
Czyszczenie
Curățare

уистка
Temizleme
清洗
洗淨
청소

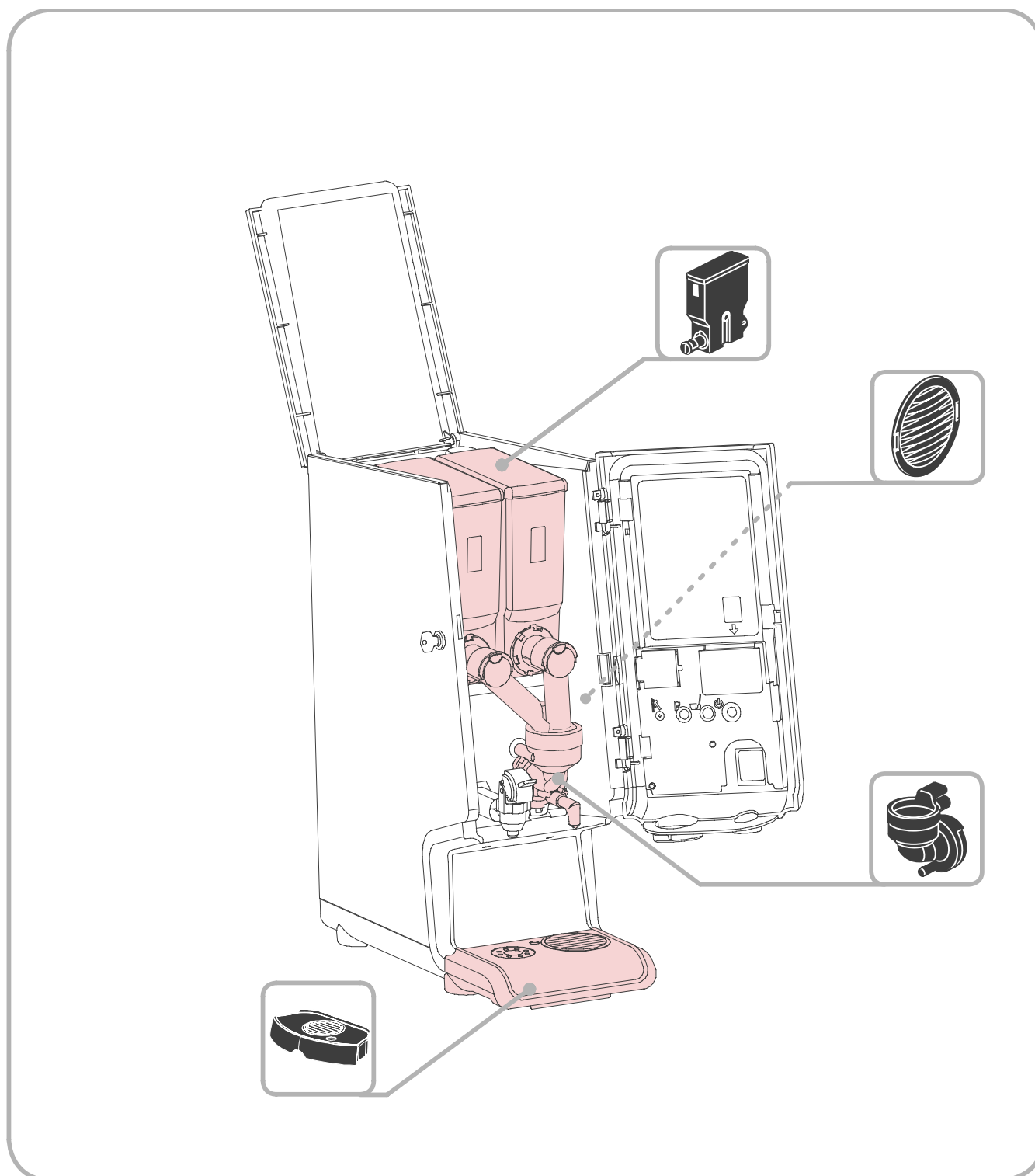

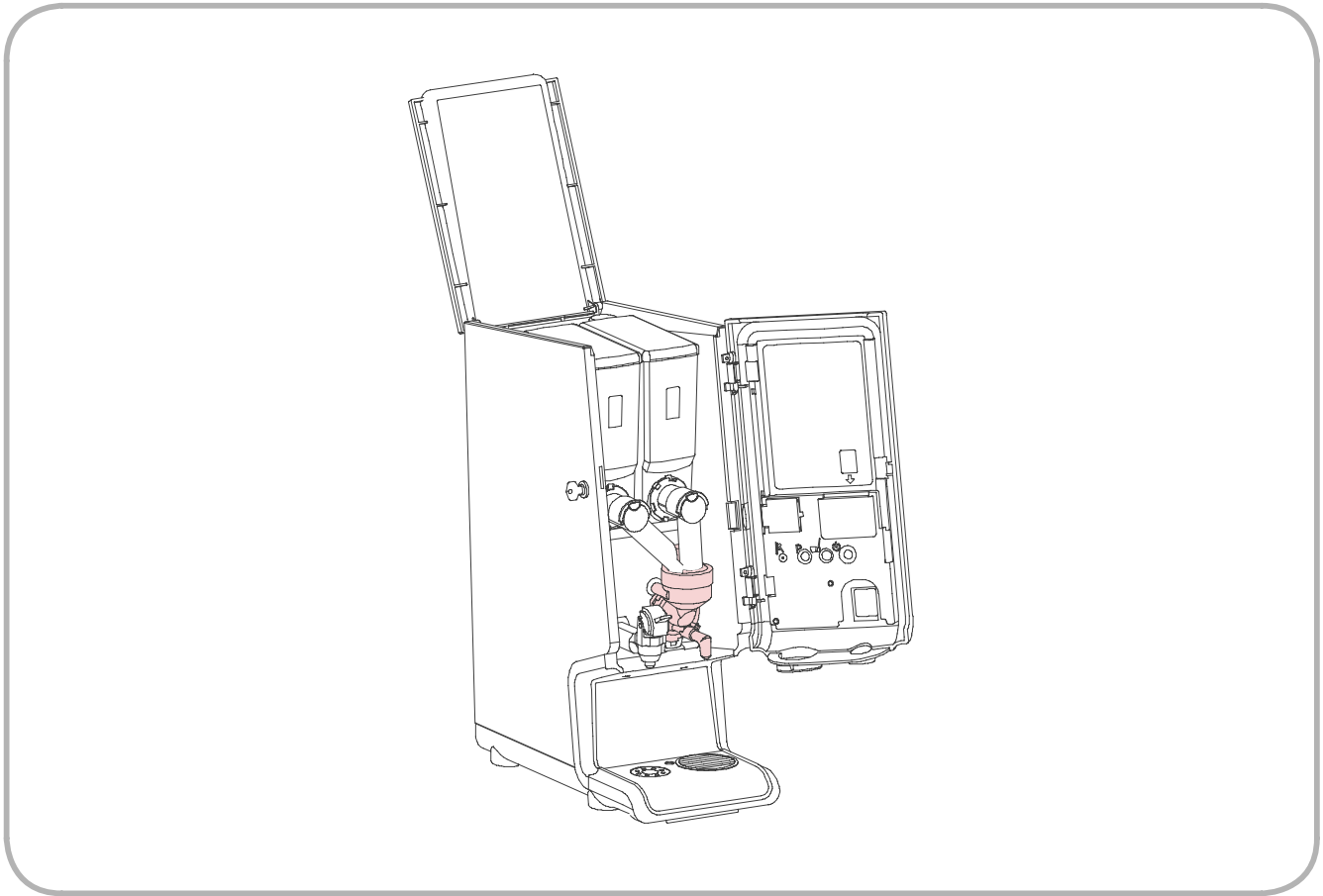
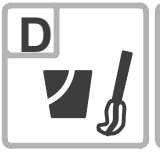



1.

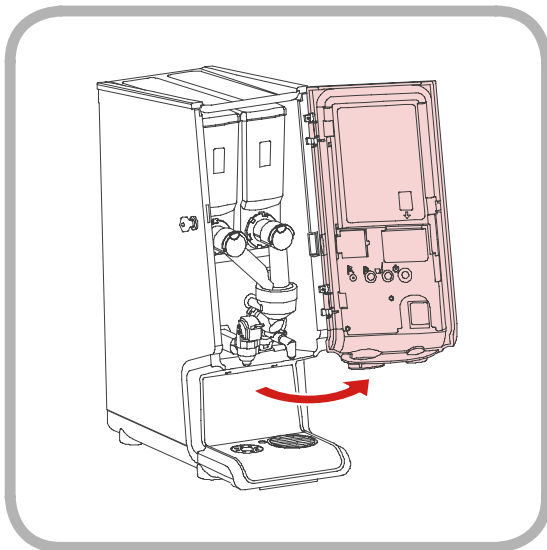

2.

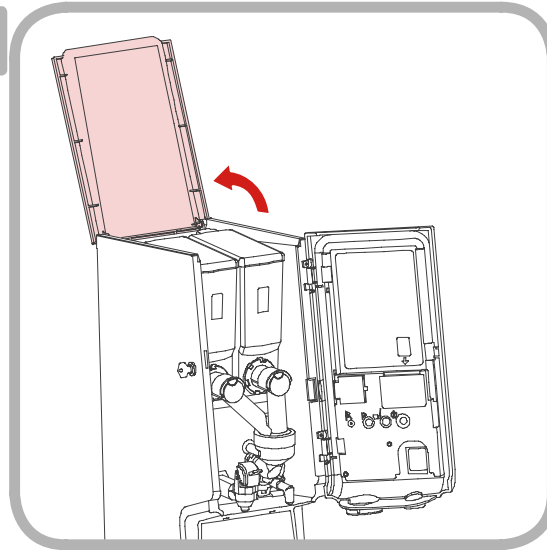

3.

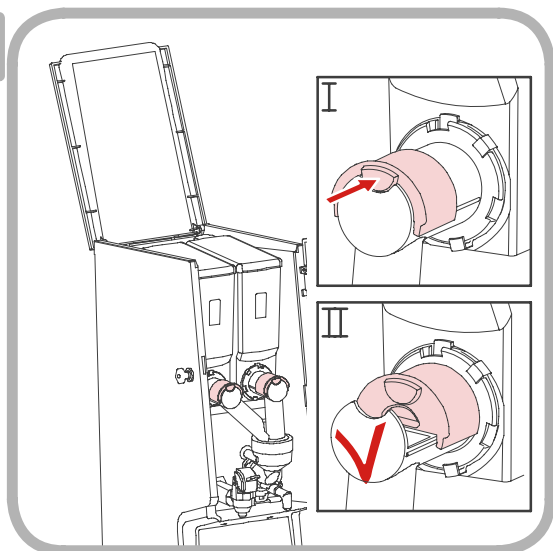

4.

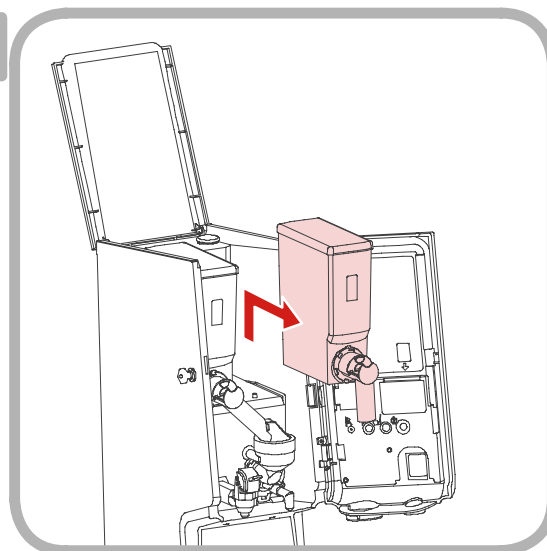

5.

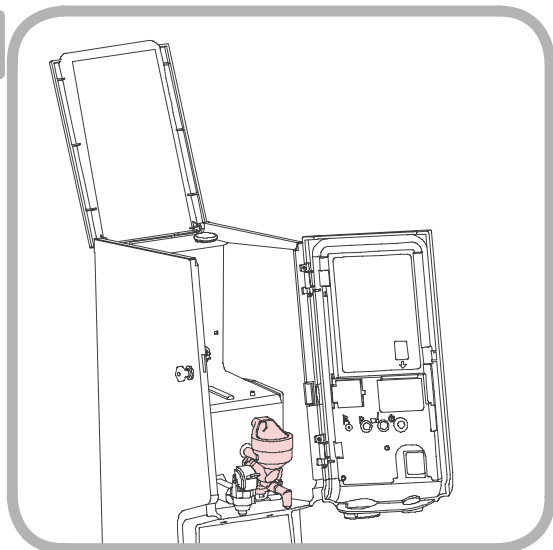

6.

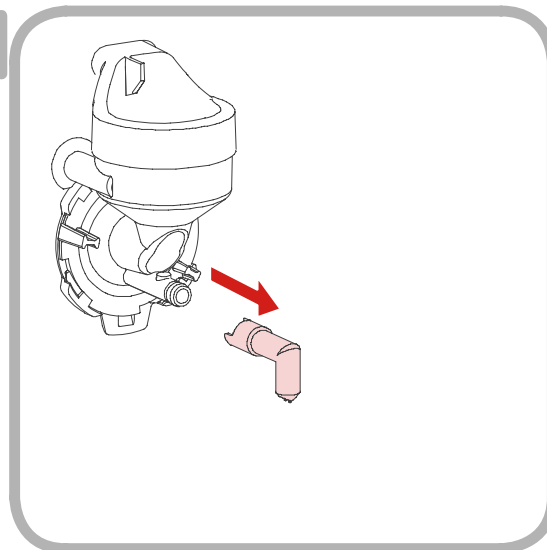

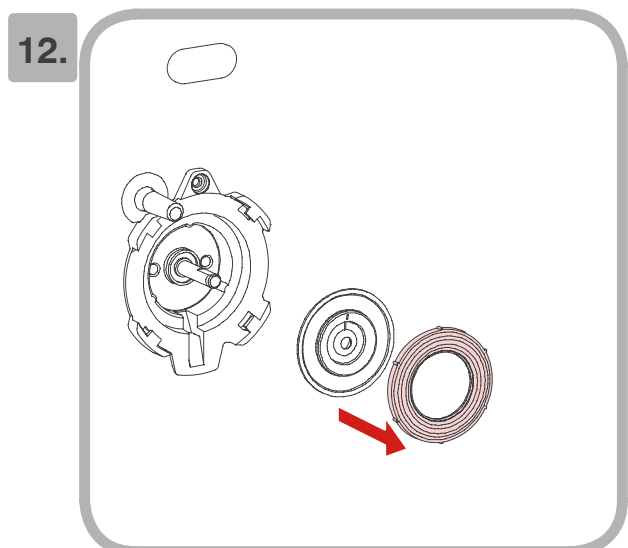
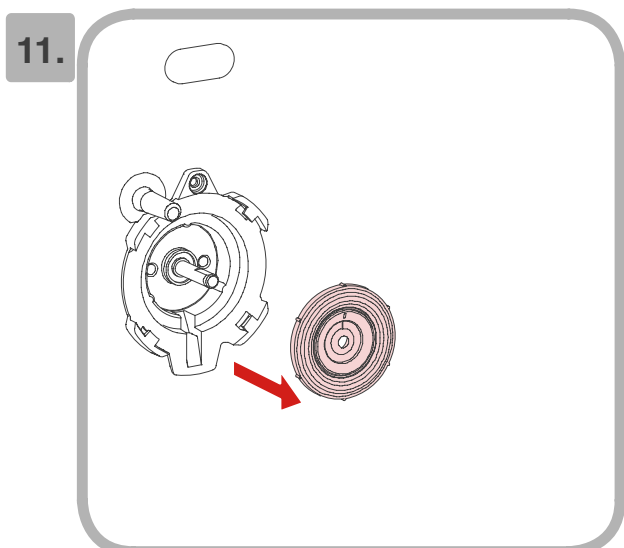
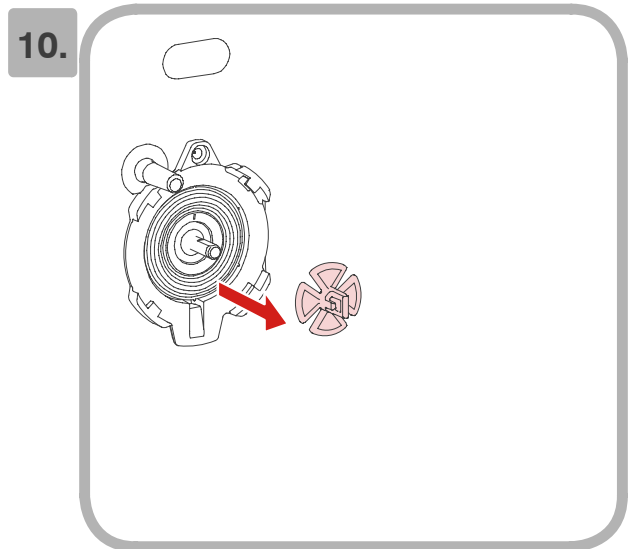
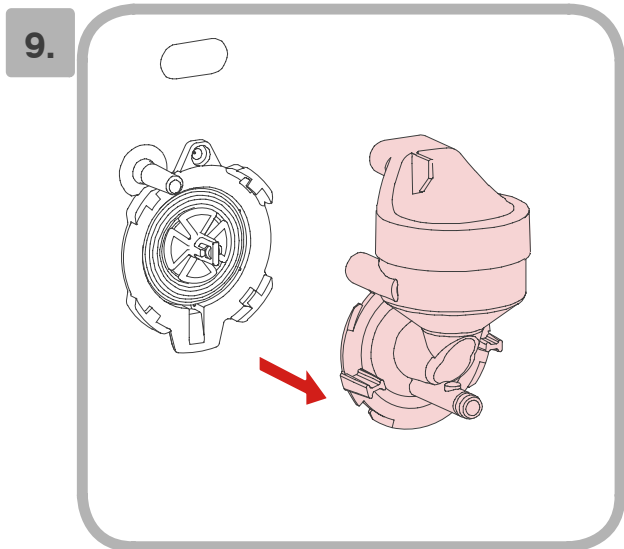
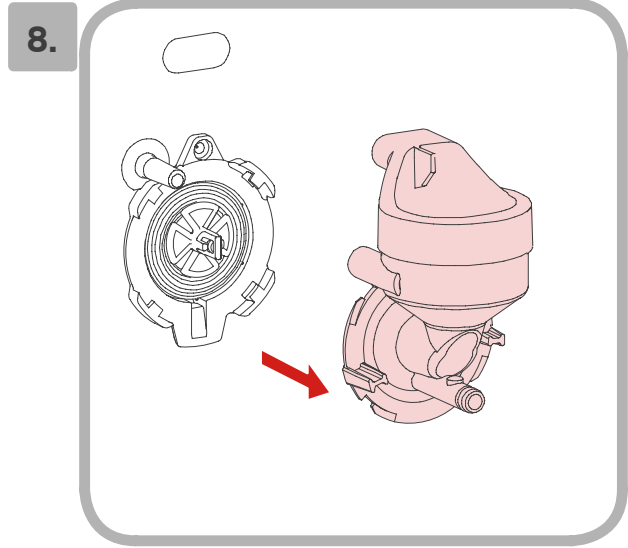
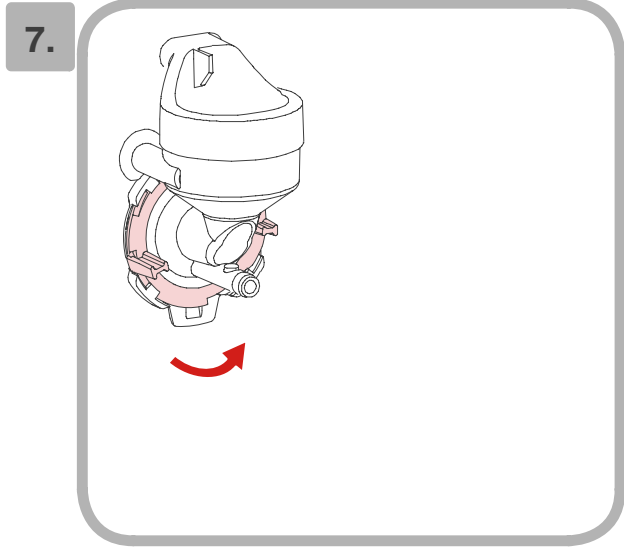



13.



14.

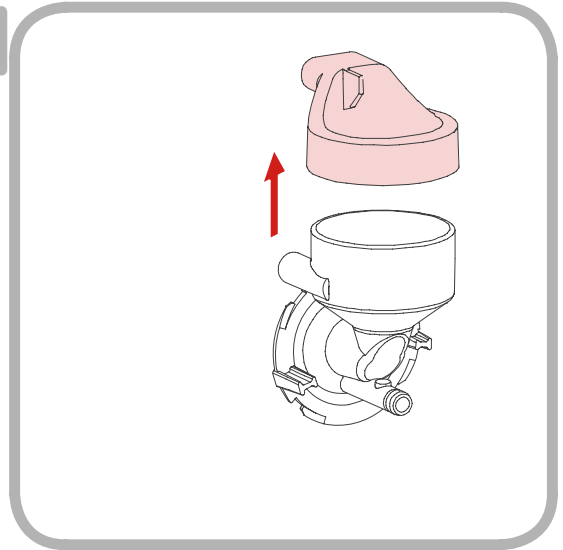

15.

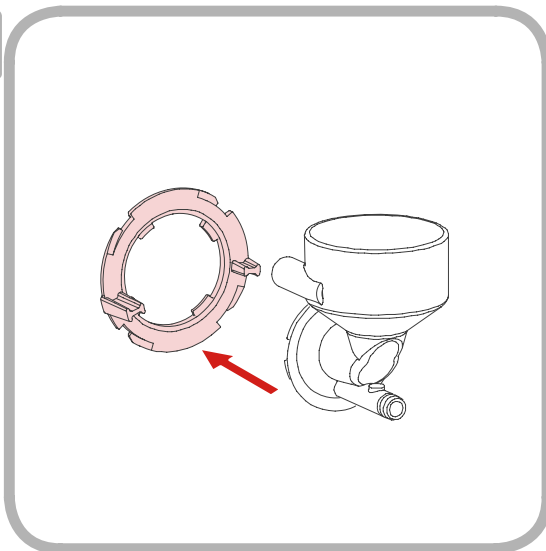

16.

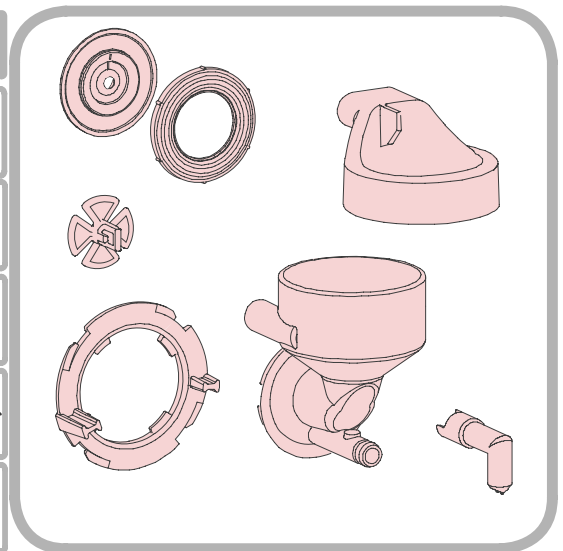

17.

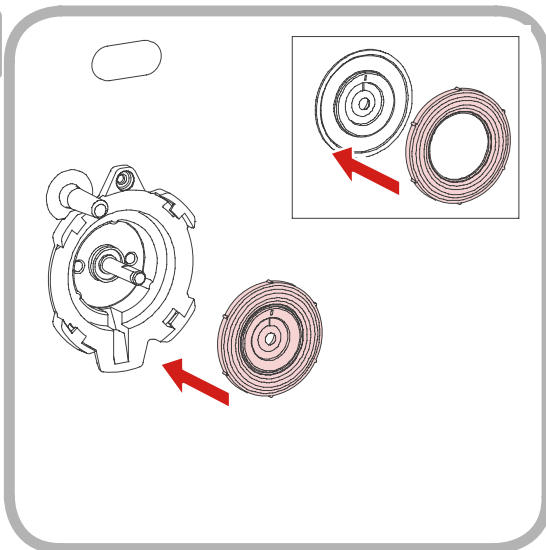

18.

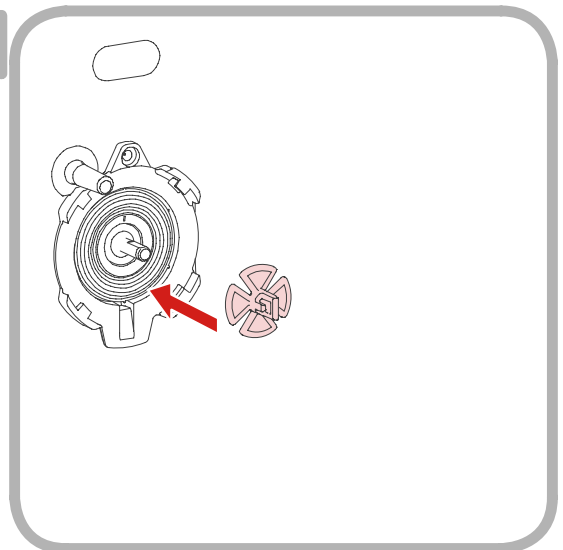



19.

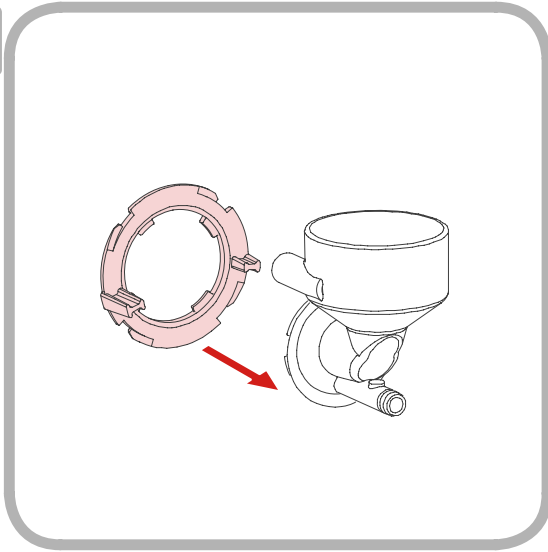

20.

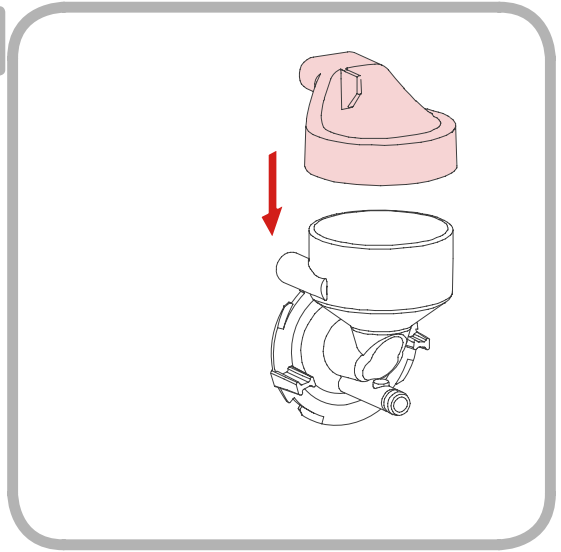

21.

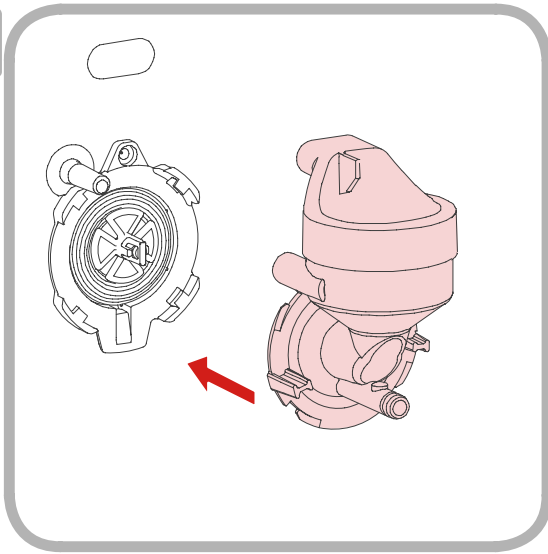

22.

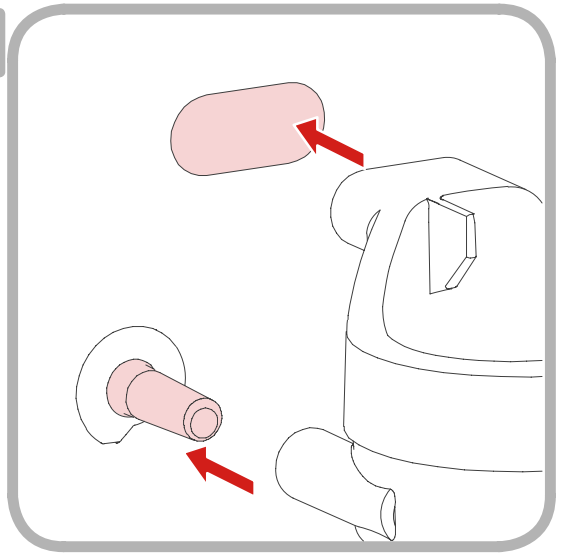

23.

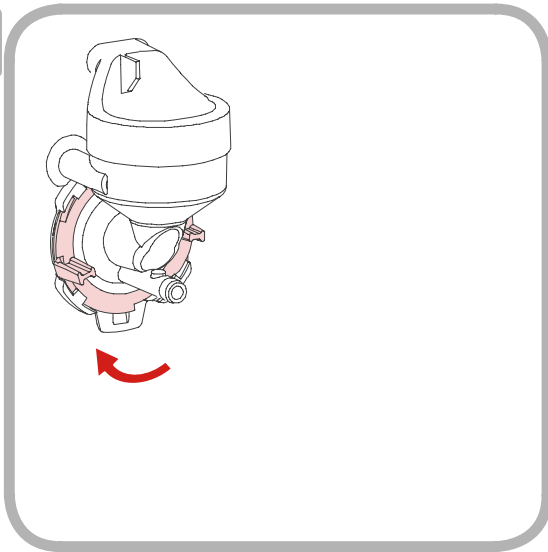

24.

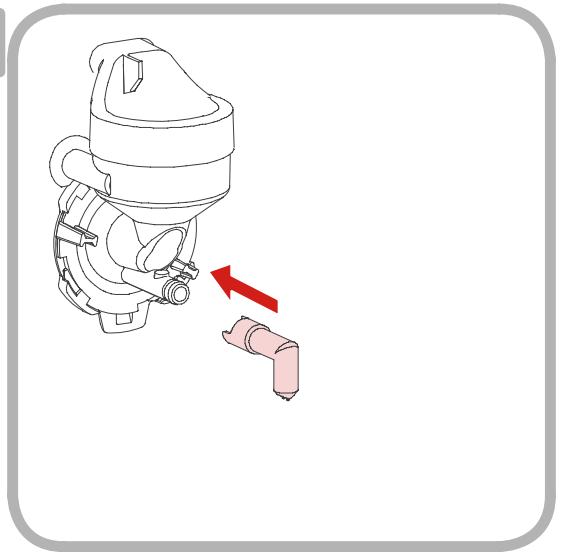



25.

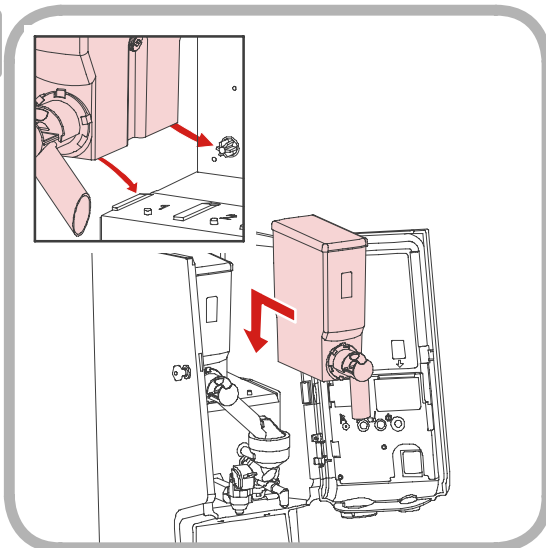

26.

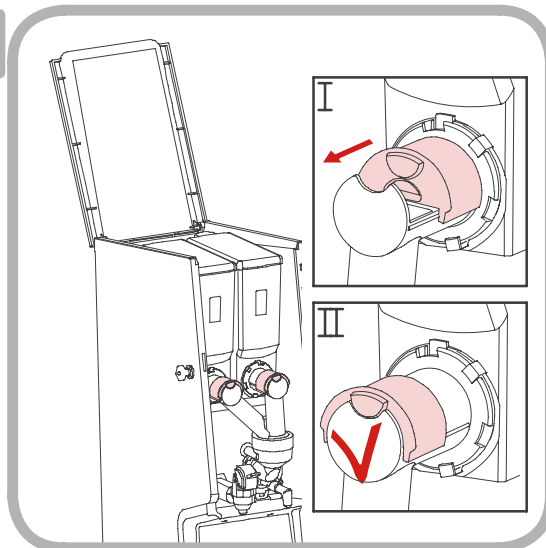

27.

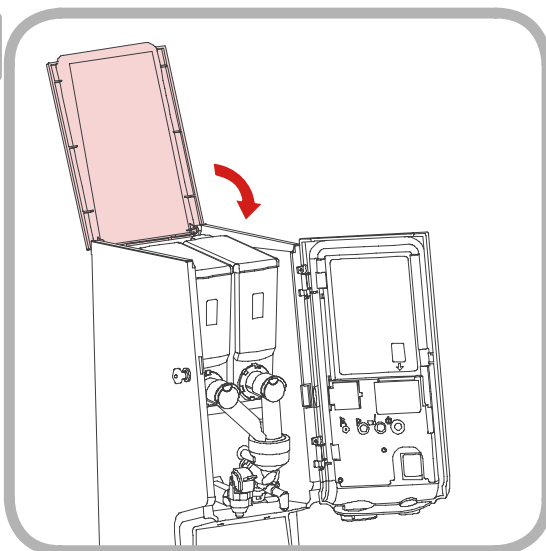

28.

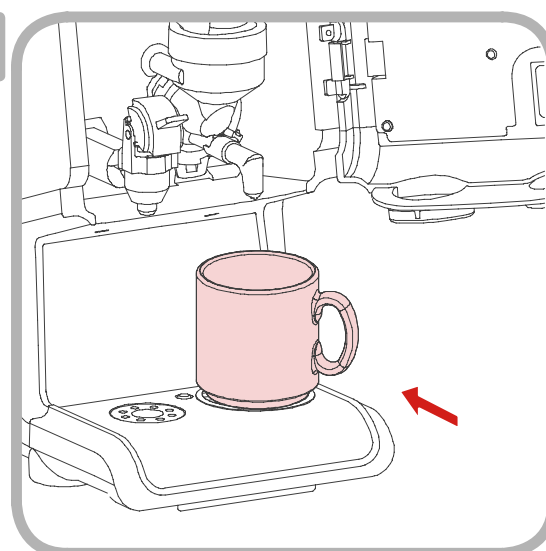

29.

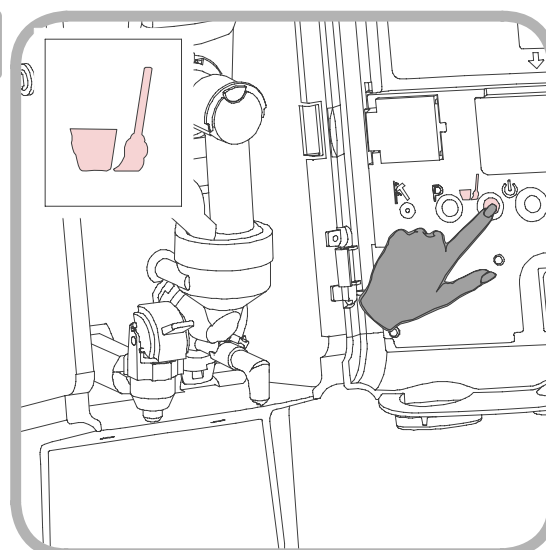

30.

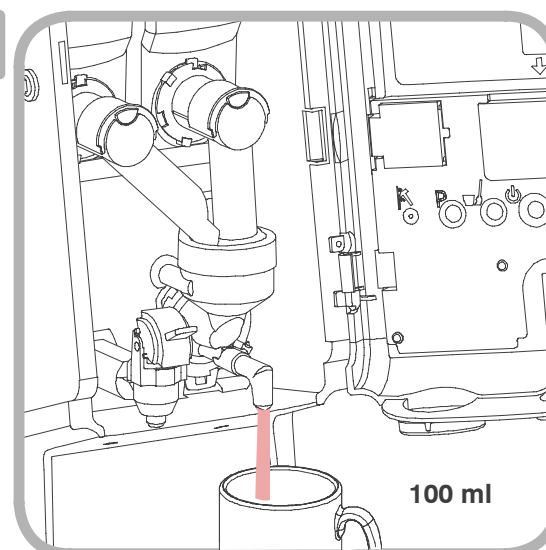

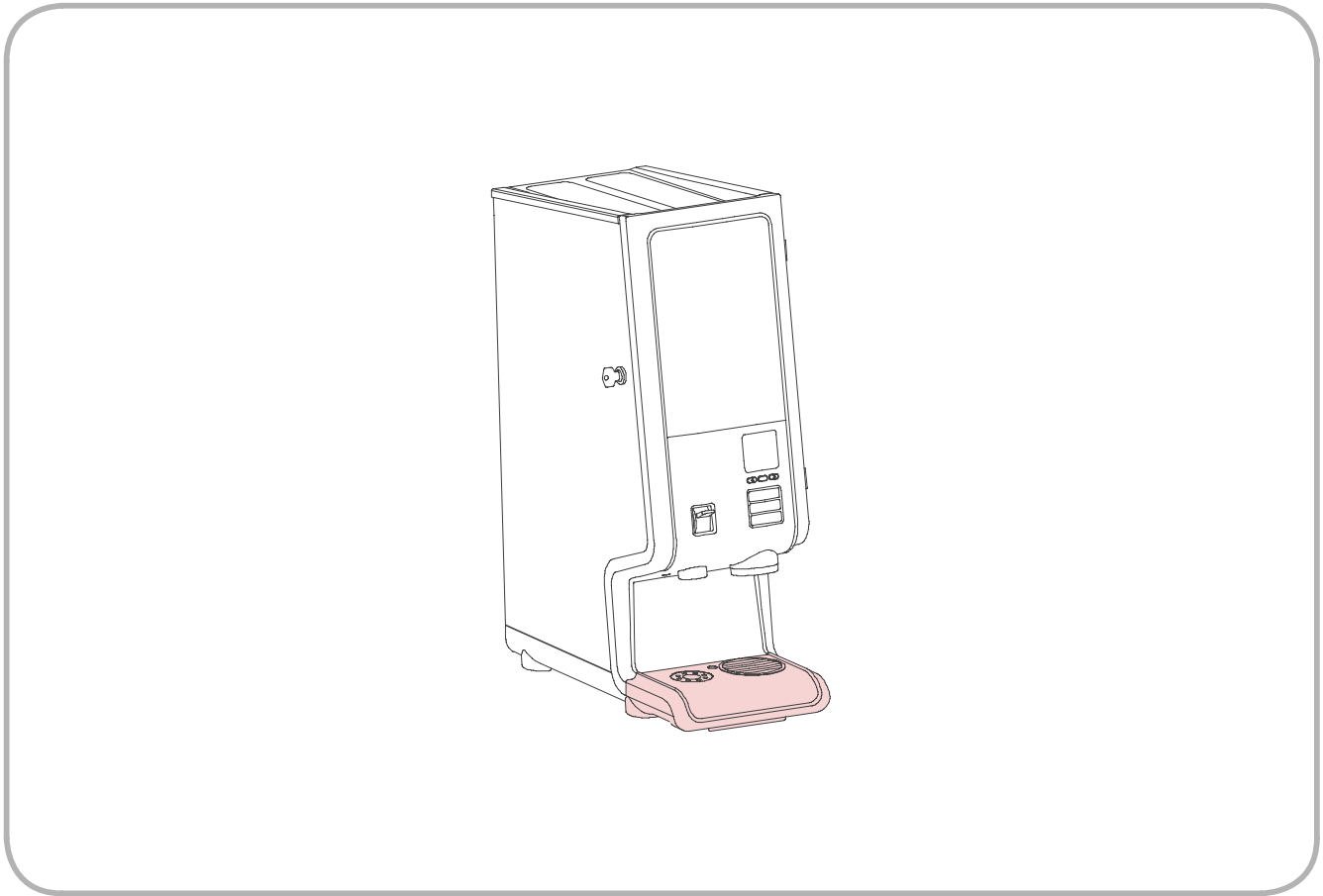
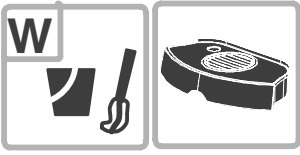

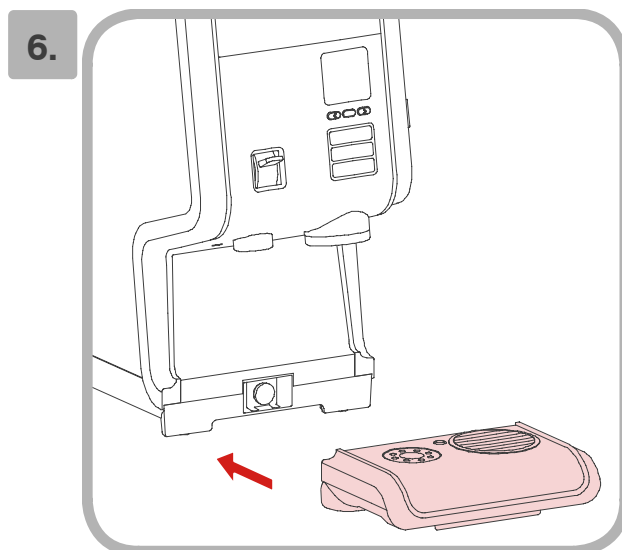
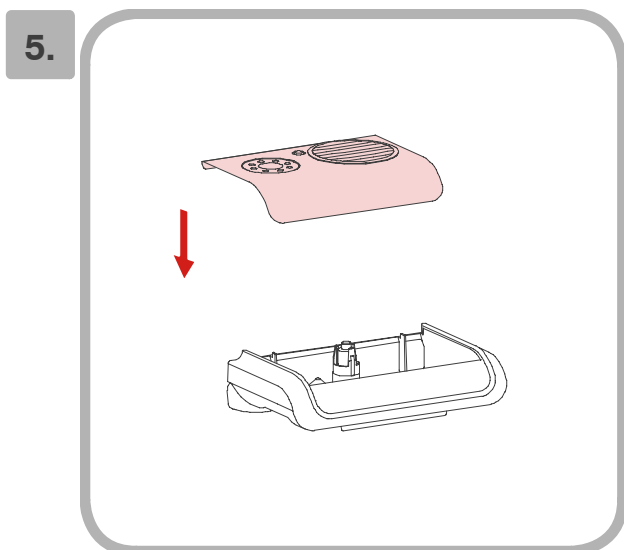
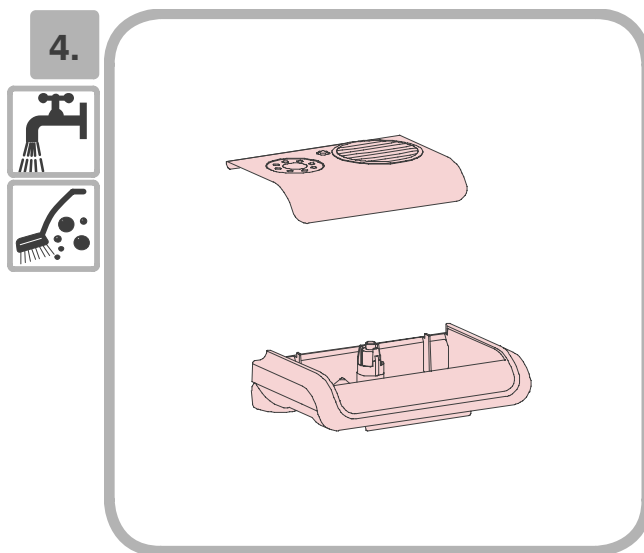
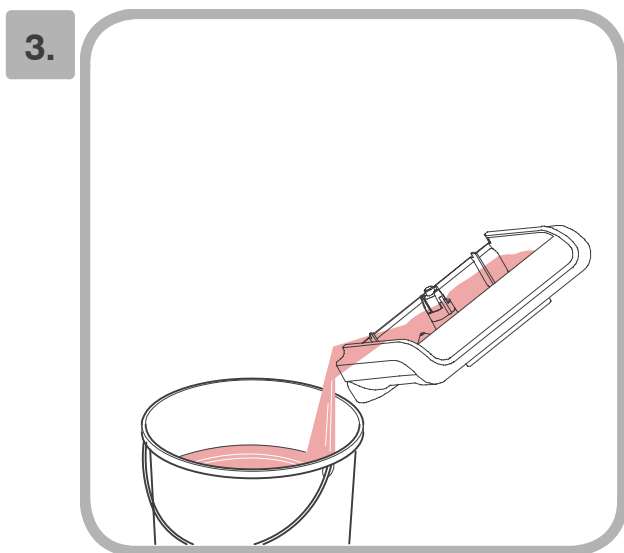
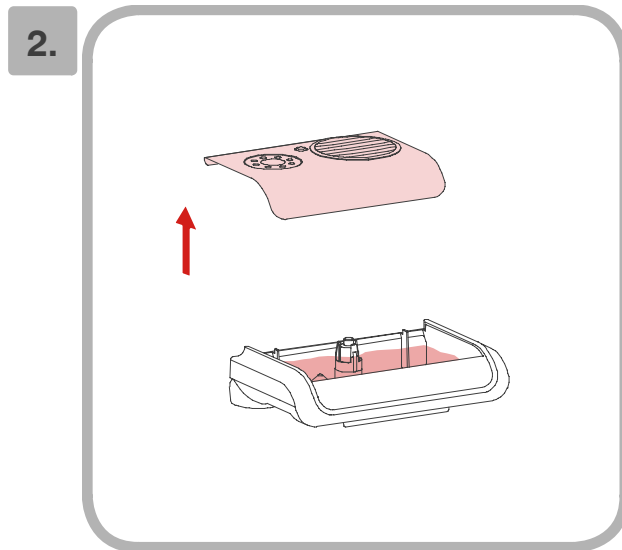
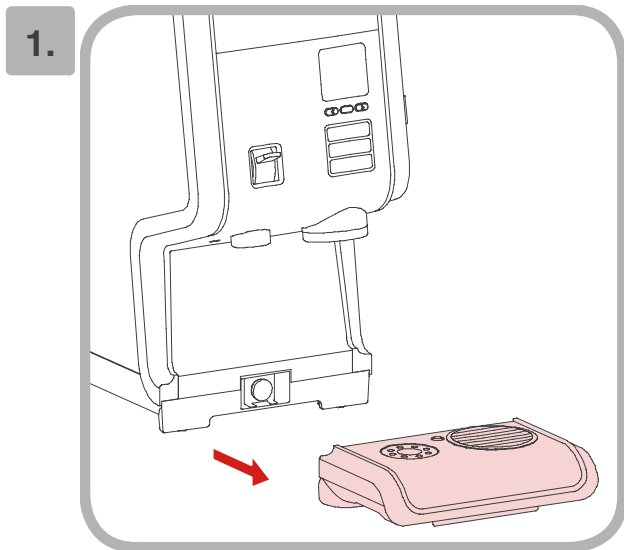

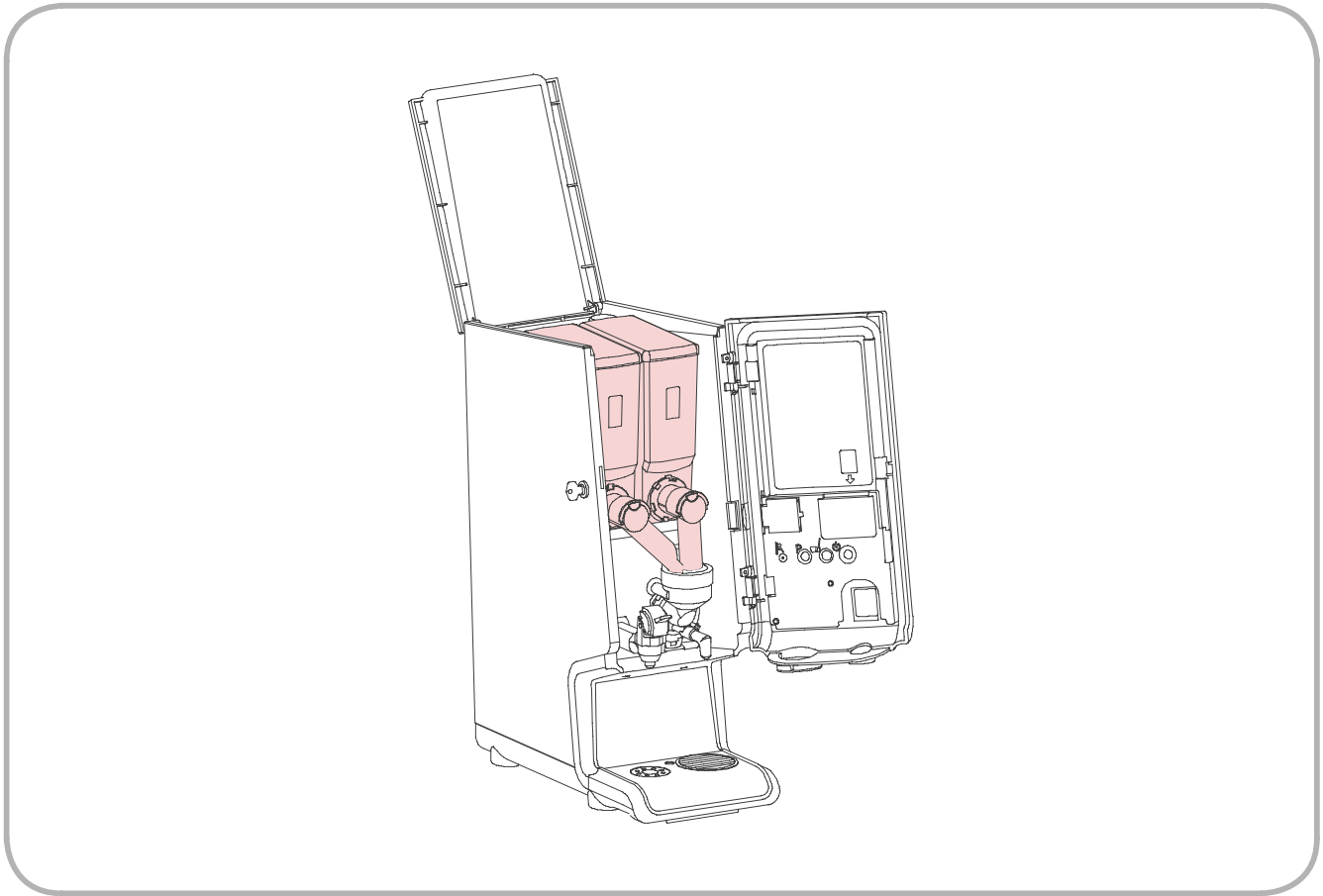
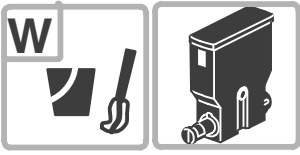



1.

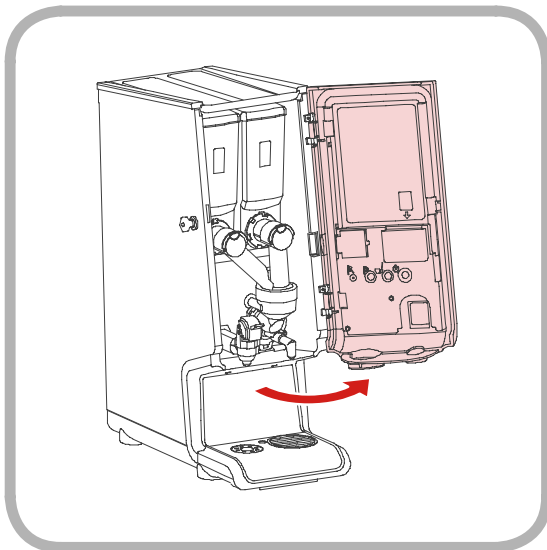

2.

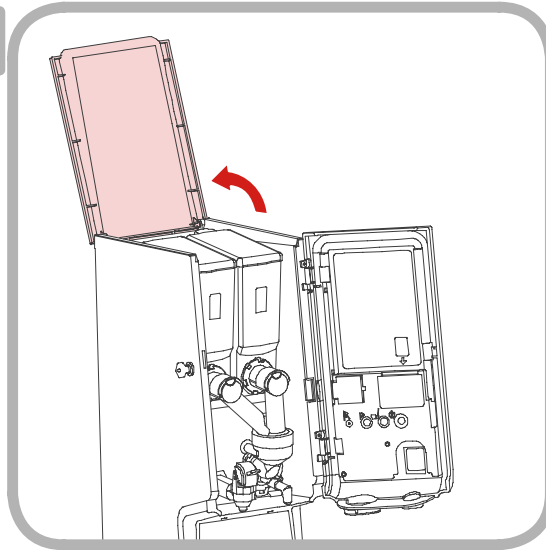

3.

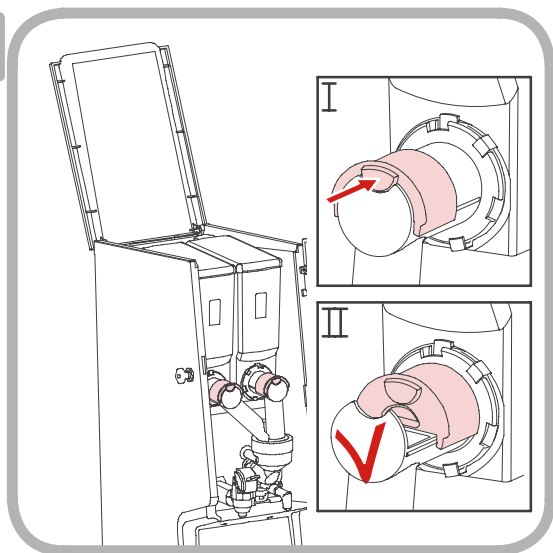

4.

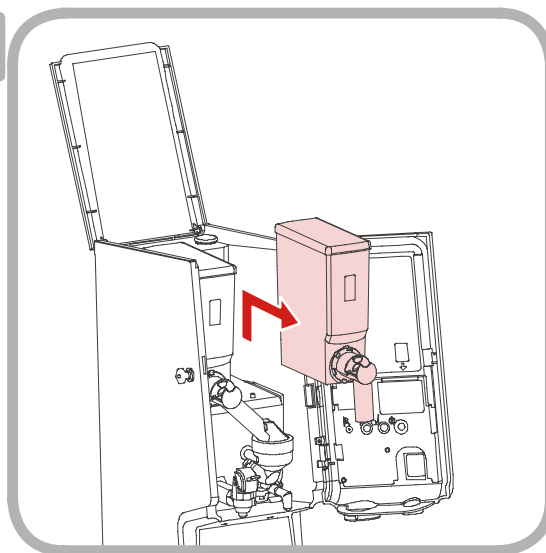

5.

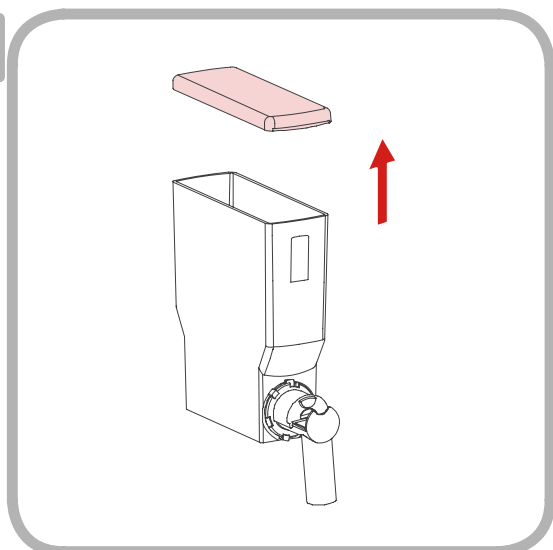

6.

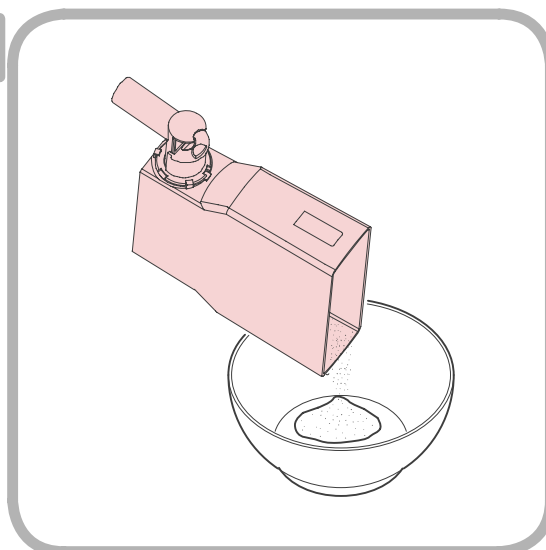

W

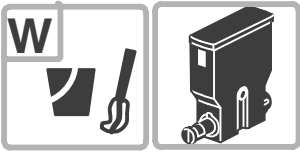

7.

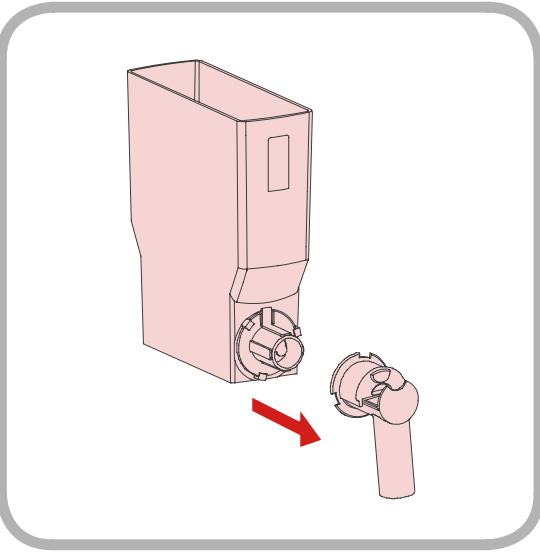

8.

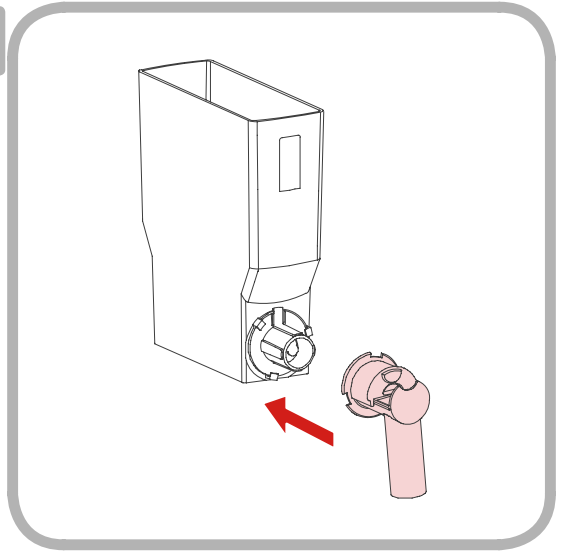

9.

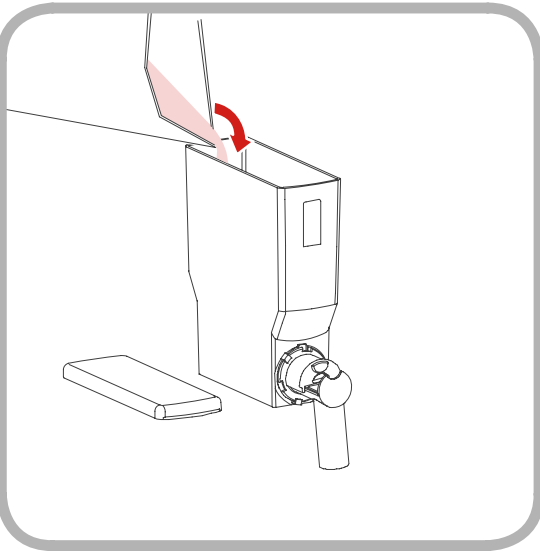

10.

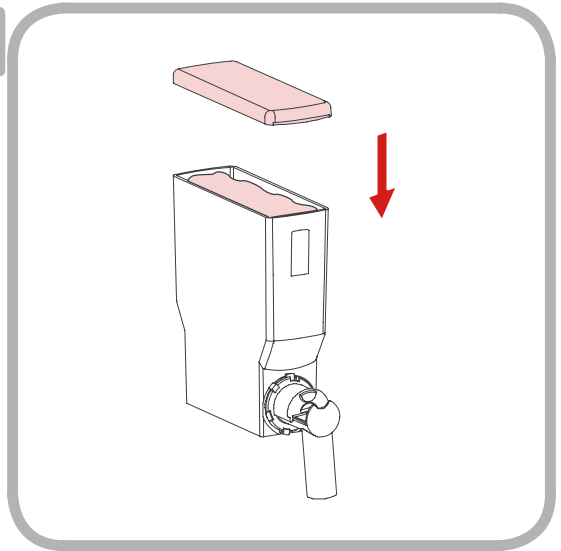

11.

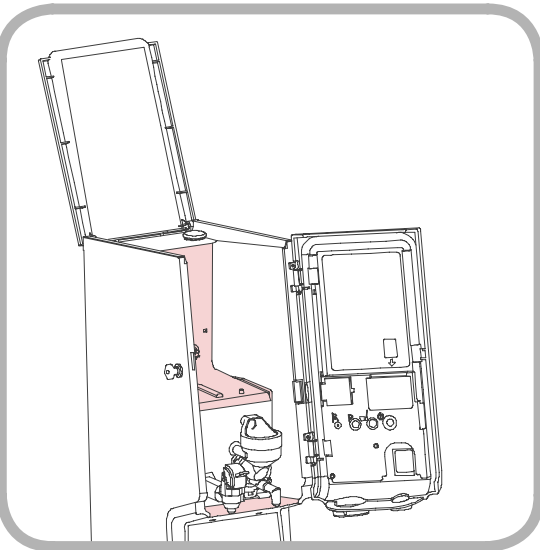

12.

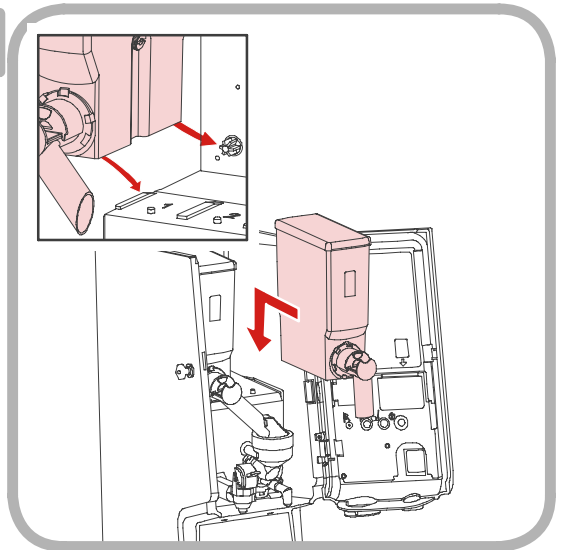

13.

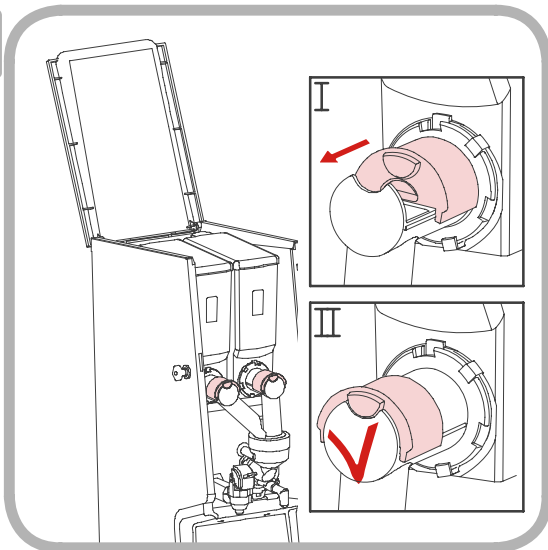

14.

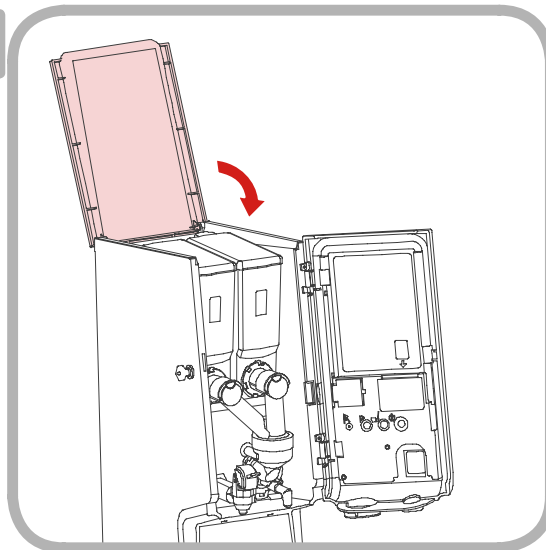

15.

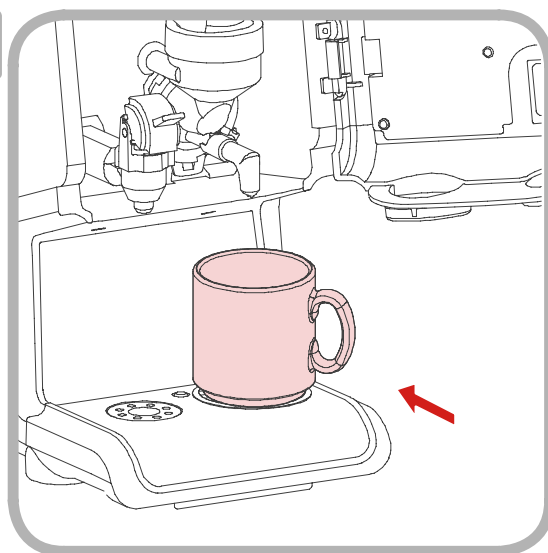

16.

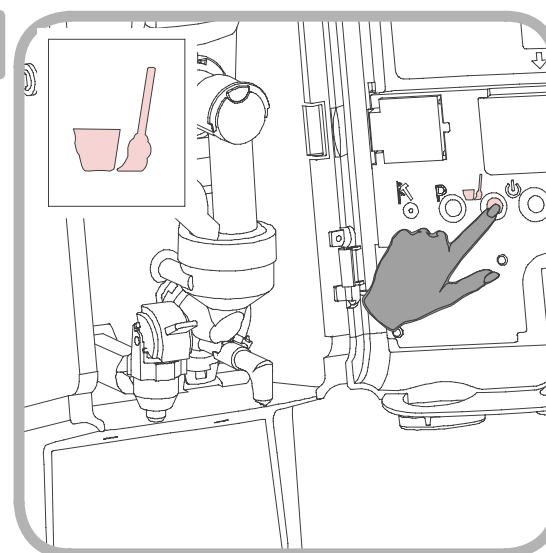

17.

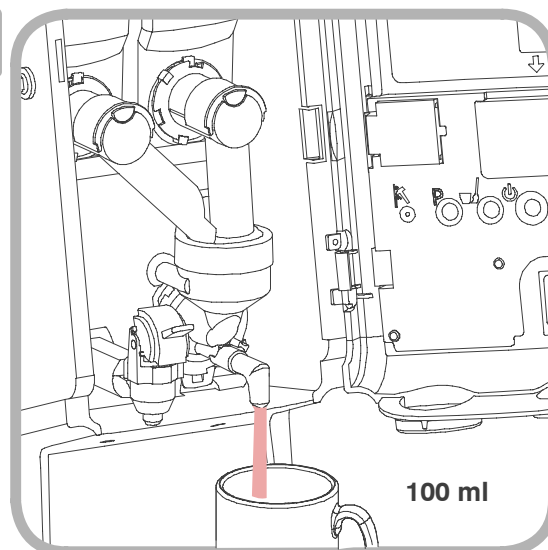

18.

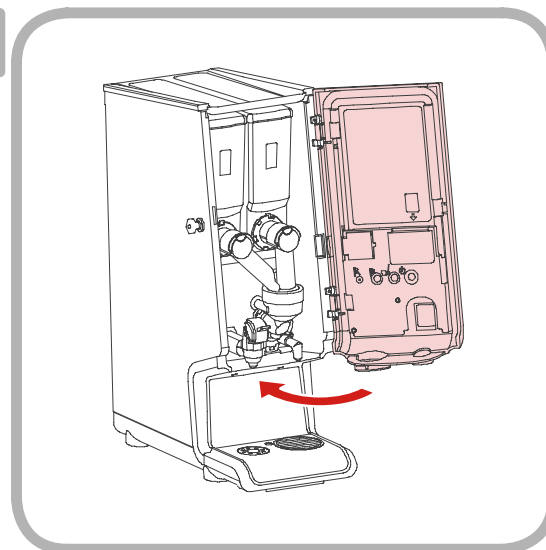

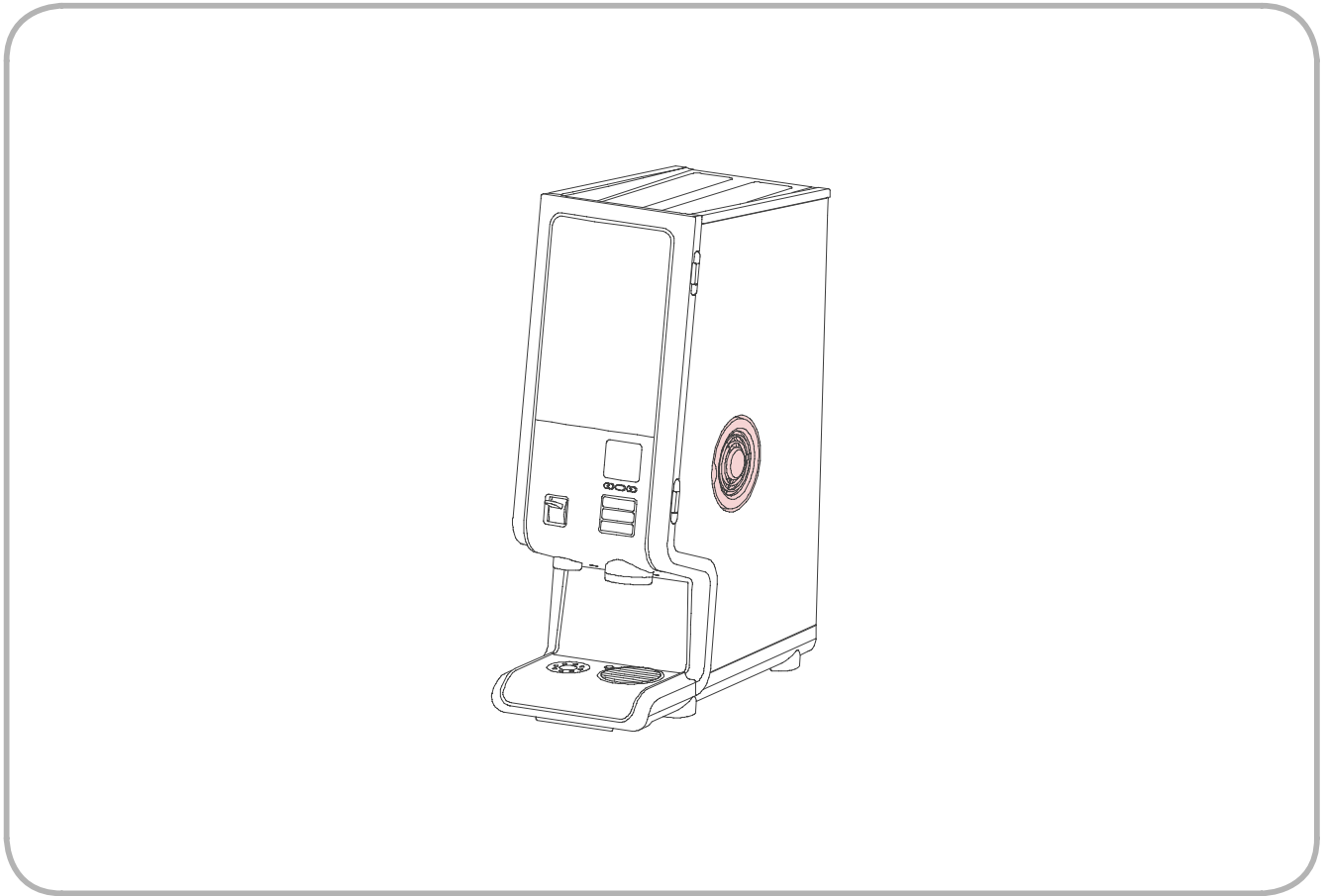
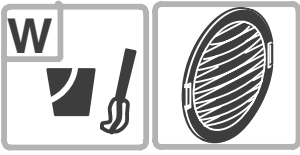

1.

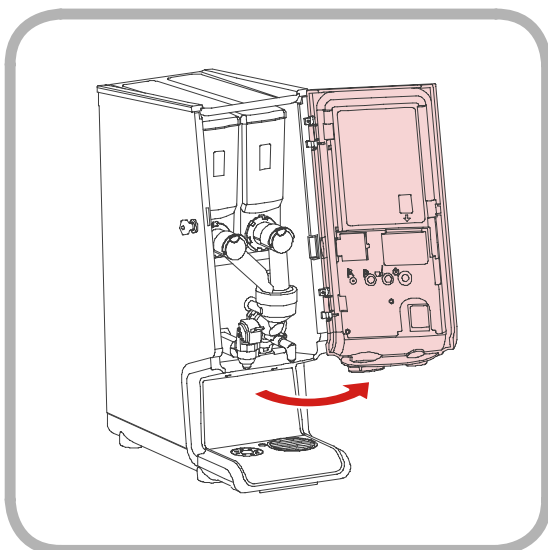

2.

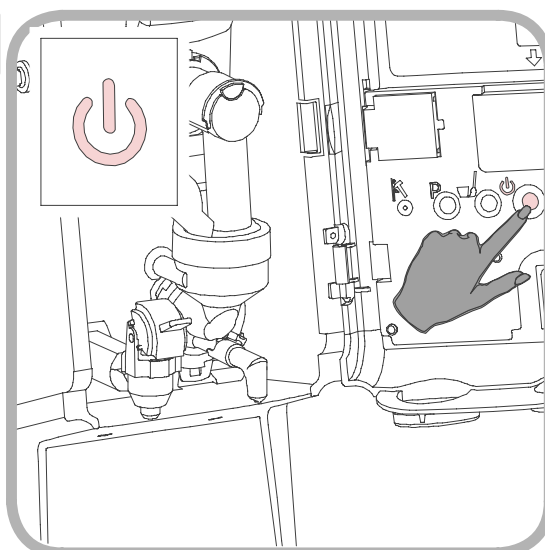

3.

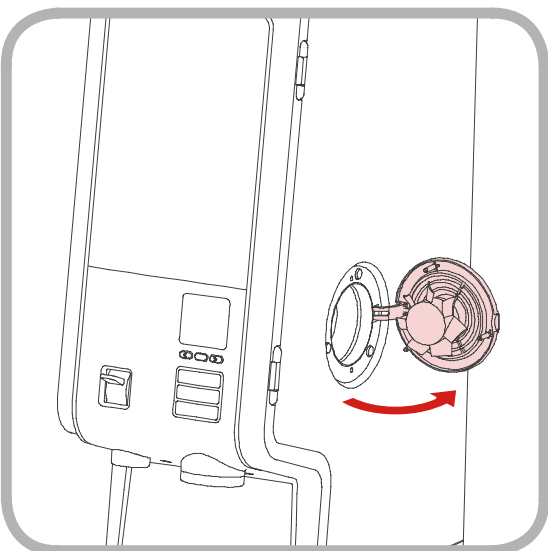

4.

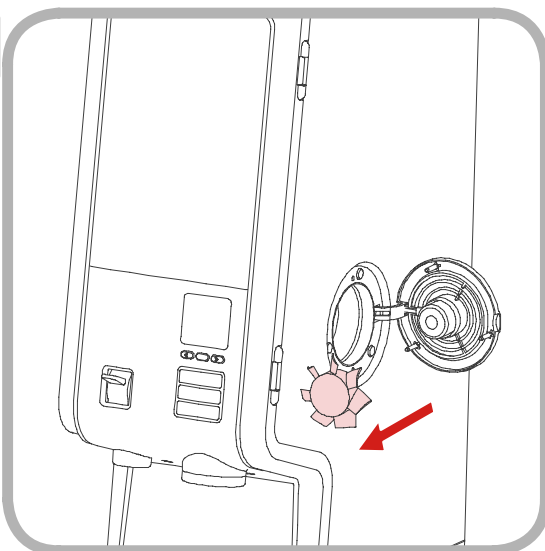

5.

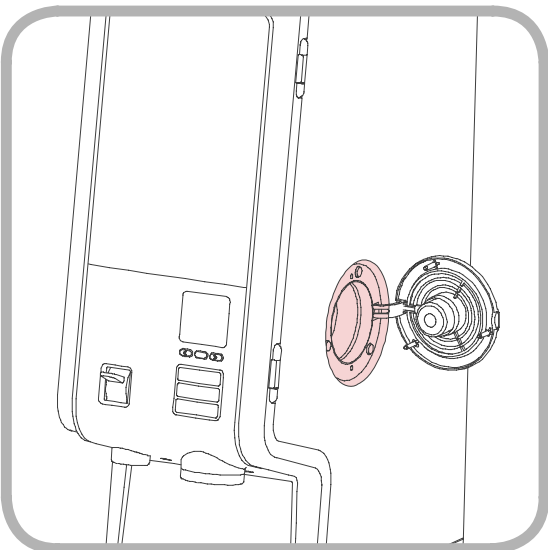

6.

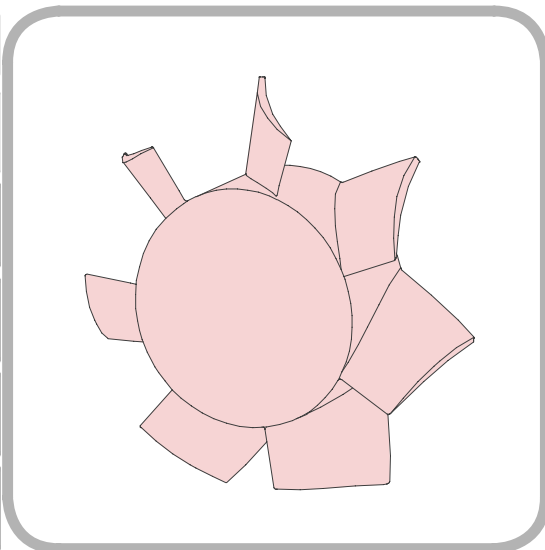

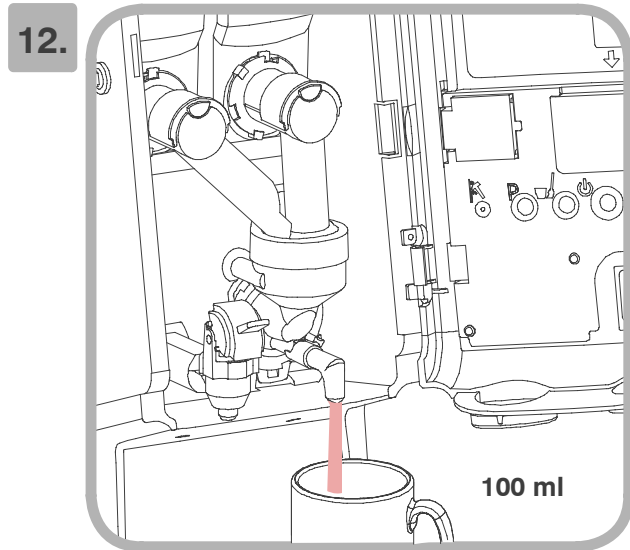
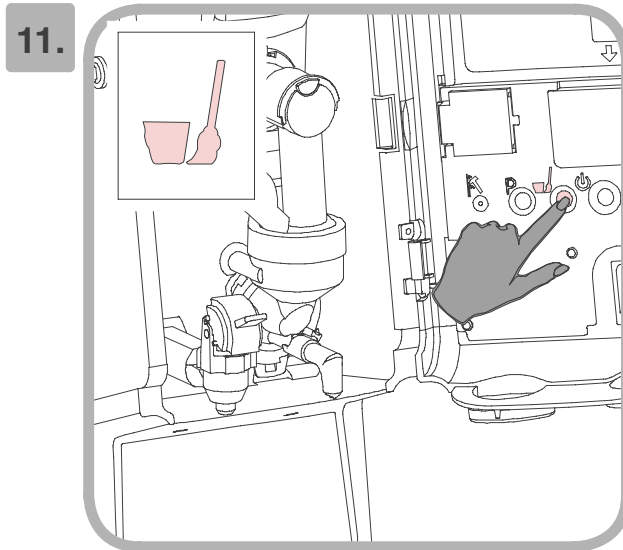
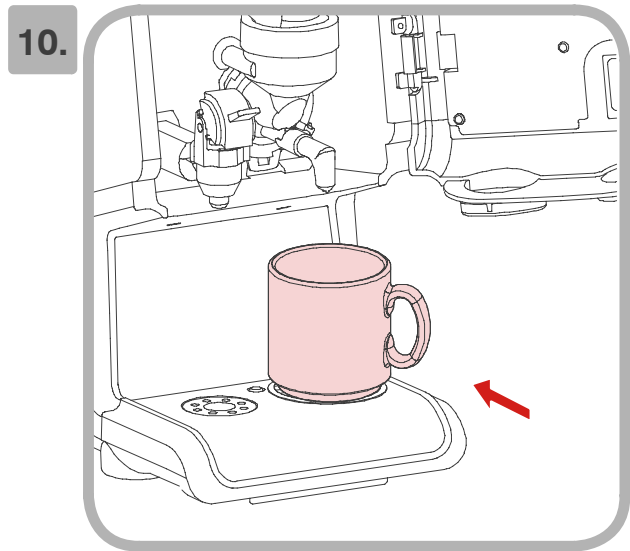
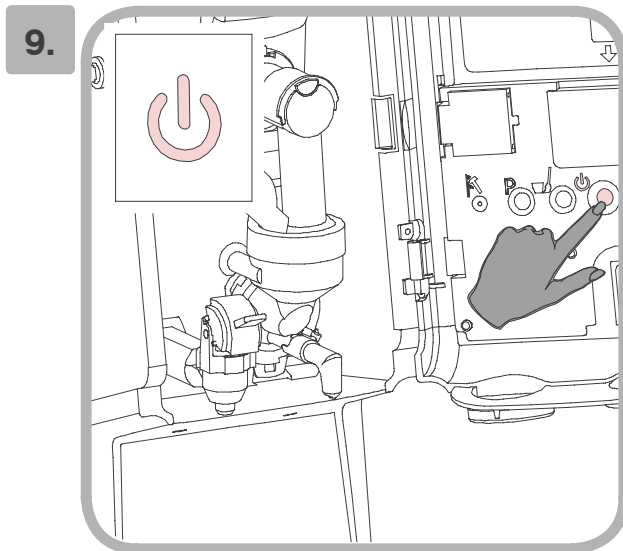
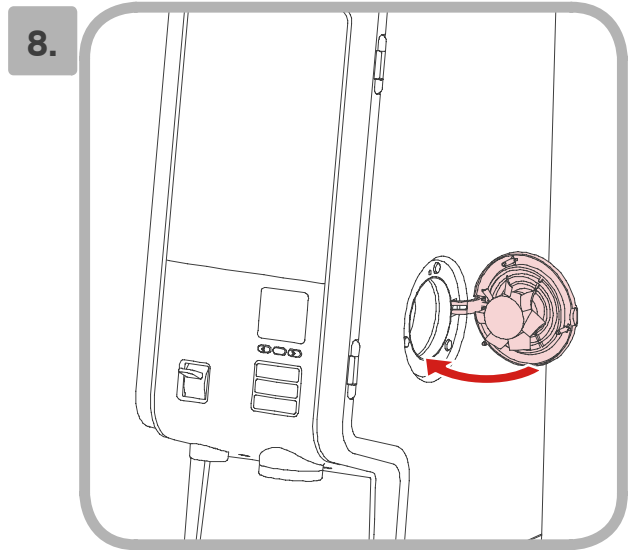
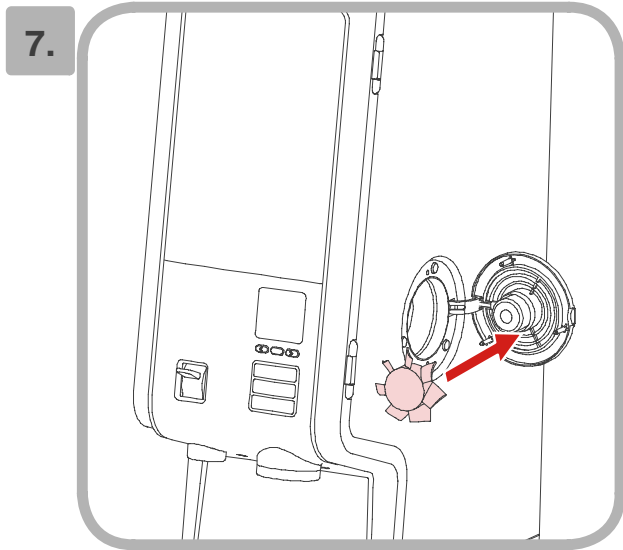
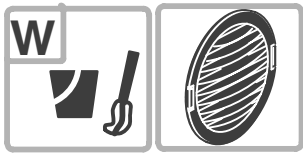

13.

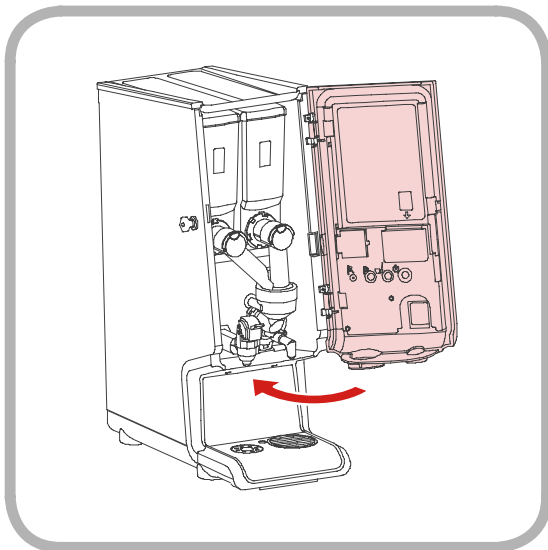

Messages
Messages
Meldungen
Meldingen
Meddelanden

Meldinger
Beskeder
Viestit
Mensajes
Mensagens

Messaggio
Μηνύματα
Zprávy
Wiadomości
Mesaje

Сообщения
Mesajlar
信息
メッセージ
메세지

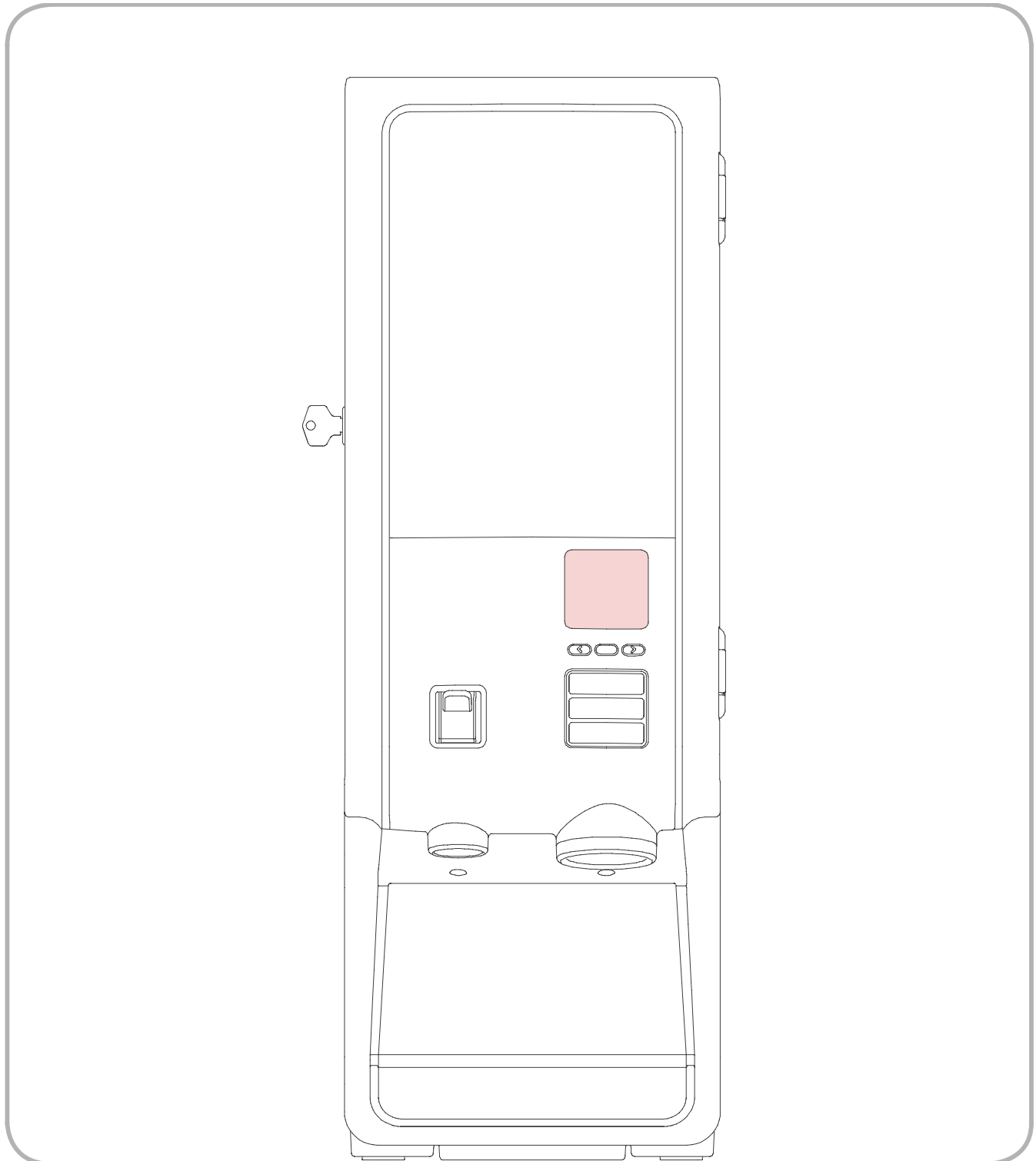

E

1.

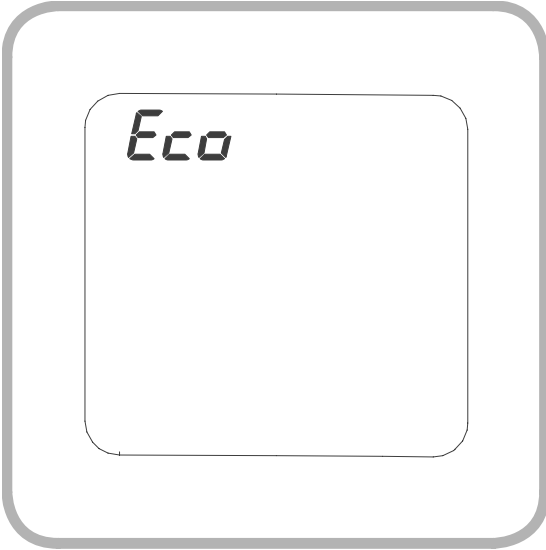

2.



3.



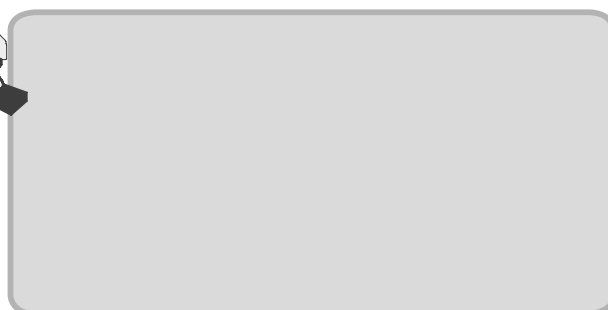
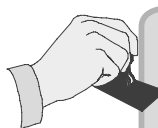
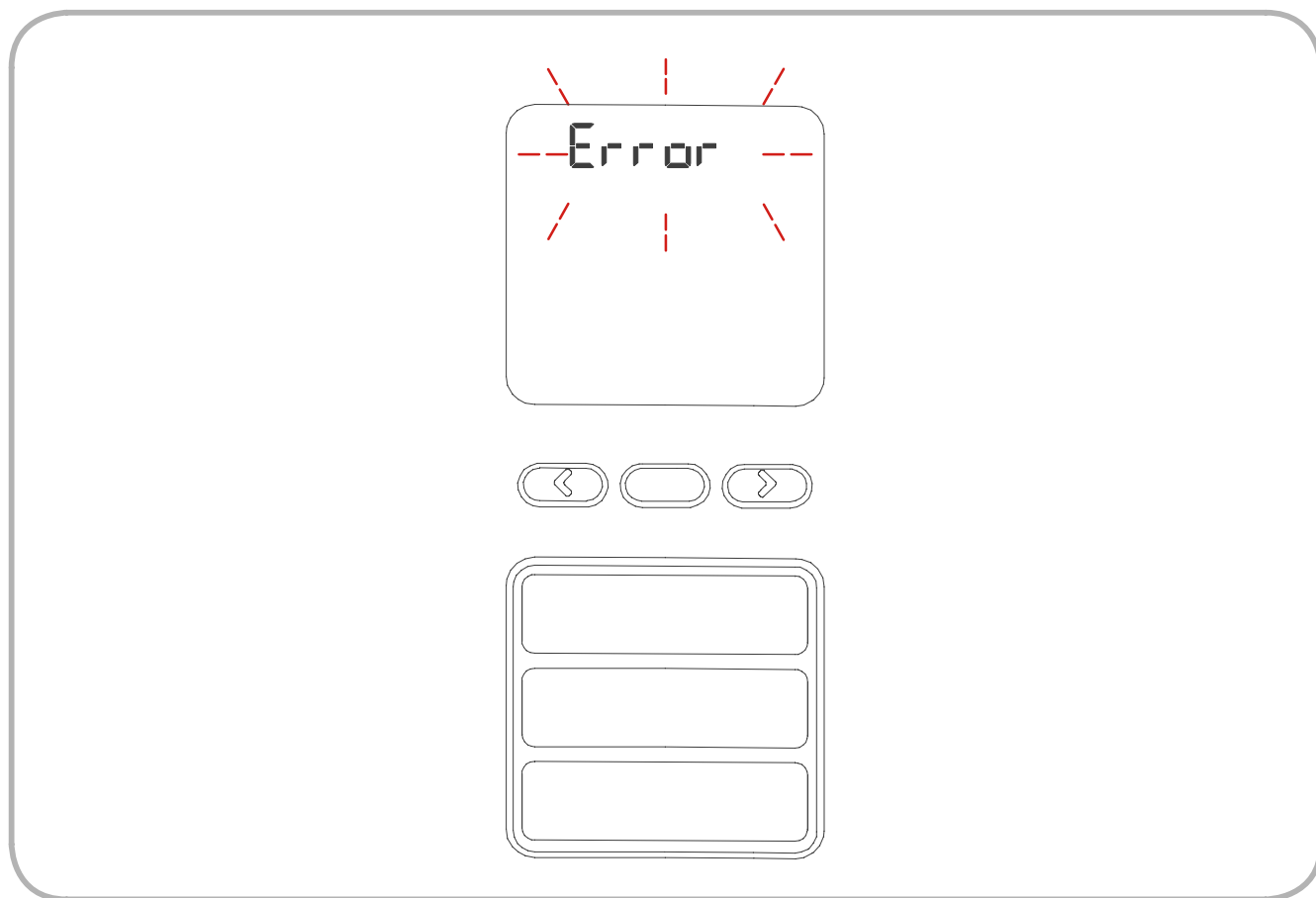

Head office

Bravilor Bonamat BV

Address : Pascalstraat 20
P.O.Box : 188
1700 AD Heerhugowaard
The Netherlands
Tel. : + 31 (0)72 57 51 751
Fax : + 31 (0)72 57 51 758
E-mail : sales@bravilor.com

Bonamat GmbH

Adresse : Brookstieg 14
D-22145 Stapelfeld
Deutschland
Tel. : (040) 60 823-0
Fax : (040) 60 823-100
E-mail : info.de@bonamat.com

Bravilor Ltd

Address : Unit 15 Cordwallis Park
Clivemont Road, Maidenhead
Berkshire SL6 7BU
United Kingdom
Tel. : (01628) – 776060
Fax : (01628) – 776035
E-mail : enquiries@bravilor.com

Bonamat Norge AS

Address : Kallerudlia 11
Postboks: 60
2801 Gjøvik
Norge
Tel. : 61 13 09 65
Fax : 61 13 09 75
E-mail : info.no@bonamat.com

Bonamat AB.

Adresse : Viggbyholmsvägen 83
18377 Täby
Sverige
Tel. : 08-622 64 50
Fax : 08-622 58 70
E-mail : info.se@bonamat.com

Bravilor Belux N.V.

Adres : Boomgaardreef 7
B2900 Schoten
Belgique / België
Tel. : (03) 663.77.22
Fax : (03) 663.77.44
E-mail : info.be@bravilor.com

Bravilor France S.A.S.

Adresse : 5, Rue Michel Carré
B.P. : N° 60034
95102 Argenteuil Cedex
France
Tél. : 01.34.34.47.74
Fax : 01.34.34.47.75
E-mail : info.fr@bravilor.com

Poland (Bravilor Bonamat BV)

Address : ul. Wankowicza 4/111
02-796 Warsaw
Poland
Tel. : (0)509-32 91 90
E-mail : info.pl@bravilor.com



Italiano
Ελληνικά
Česky
Polski
Română



Русский
Türkçe
中文
日本語
한글

Prescrizioni di sicurezza
Έντυπο ασφαλείας
Bezpečnostní kniha
Wskazówki
bezpieczeństwa
Carte instructaj



Инструкция по
эксплуатации
Güvenlik kitabı
安全冊子
安全説明書
안전 지침서

Manuale per l'operatore
Εγχειρίδιο χειρισμού
Provozní příručka
Instrukcja obsługi
Manualul operatorului



Руководство оператора
Operatör kılavuzu
操作手册
操作マニュアル
동지 설명서

Elenco prodotti
Πίνακας συστατικών
Přehled směsí
Lista składników
Listă ingrediente



Список ингредиентов
İçindekilerin listesi
成份清單
材料リスト
원재료 목록

Attendere
Αναμονή
Čekajte
Czekaj
Aşteaptă



Ждите
Bekle
等候
待つ
기다림

Penello
Βούρτσα
Kartáč
Szczotka
Perie



уистить щёткой
Fırçala
洗刷
ブラシ
붓

Panno umido
Υγρό πανί
Vlhká látka
Wilgotna szmatka
Cârpă umedă



Влажная салфетка
Nemli bez
濕布
濕った布
젖은헝겂

Lavaggio
Ελαφριά πλύση
Vypláchnout
Płukanie
Clătire



Прополоскать
Durula
沖洗
すすぐ
세척

Detersivo
Απορρυπαντικό
Prostředek na odvápnění
Środek myjący
Detergent



уистящее средство
Deterjan
去污劑
洗劑
세정제

Idoneo per lavastoviglie
Εγγυημένο για χρήση σε
πλυντήριο πιάτων
Myčka –důkaz
Mycie w zmywarce
dozwolone
Spälåtor veselä



Допускается Ристка в
посудомоеРной машине
Bulaşık makinası uyumlu
可放於洗碗碟機清洗
食器洗い機で使用可能
접시세척기 사용금지

Risparmiatore energia
Εξοικονόμηση ενέργειας
Ochrana energie
Pogram "eco"
Mod economic



Накопитель энергии
Enerji tasarrufu
節省能源
省エネルギー
에너지 절약

Chiamare il fornitore
Καλέστε τον αντιπρόσωπο
/ διανομέα
Volejte dodavatele
Teefon do dystrybutora
Cheamă distribuitorul



Позвоните
дистрибутору
Çağrı distribütörü
聯絡經銷商
販売店に連絡して下さい
전화 교환기

Decalcificazione
Αφαλάτωση
Odvápnění
Odkamienianie
Decalcarizare



уистка от накипи
Kireçten arındırma
除垢
デスケール
스케일 청소



Italiano
Ελληνικά
Česky
Polski
Română



Русский
Türkçe
中文
日本語
한글

- Informazione  Информация
Πληροφορίες Bilgi
Informace 資料
Informacja 情報
Informație 알 령
- Indice  Содержание
Περιεχόμενα İçindekiler
Obsah 內容目錄
Spis treści 目次
Index 목 차
- Istruzione d'uso  Обслуживание
Χειρισμός Kullanım
Obsluha 操作
Instrukcja obsługi 取り扱 い
Instalare 취 급
- Selezione pulsante  Выбрать напиток
Πλήκτρο επιλογής Seçim Düğmesi
Volba tlačítek 選擇按鍵
Przycisk selekcyjny 選擇ボ タン
Buton selectare 선택버턴
- Acqua  Вода
Nepó Su
Voda 水
Woda 水
Apă 물

- Riempire / scaricare  Наполнить / опорожнить
Ένδειξη γεμάτο / Άδειο Doldurma / Boşaltma
Plný / prázdný 滿/空
Peľny / pusty 給水・空にする
Plin / Gol 채움/팅민
- Pulizia  устка
Καθαρισμός Temizleme
Čištění 清洗
Czyszczenie 洗淨
Curațare 청 소
- Pulizia giornaliera  устка ежедневно
Καθημερινή καθαριότητα Temizlik, günlük
Čištění, denně 清洗・每日
Czyszczenie, dzienne 每日の洗淨
Curațare, zilnic 일일 청소
- Pulizia settimanale  устка раз в неделю
Εβδομαδιαία καθαριότητα Temizlik, haftalık
Čištění, týdně 清洗・每週
Czyszczenie, tygodniowe 每週の洗淨
Curațare, săptămânal 주별 청소
- Contentitore prodotto  Канистра
Μεταλλικό δοχείο Kutu
Zásobník 罐子
Kanister 호ッパー
Canistră 케니스터
- Miscelatore  Смеситель
Σύστημα ανάμειξης Karışma sistemi
Mísící system 混合系統
System mieszający 攪拌系統
Sistem amestecare 교반기
- Sistema ventilazione  Система вентиляции
Σύστημα εξαερισμού Havalandırma sistemi
Odvzdušňovací system 通風系統
System chłodzenia 通風系統
Sistem ventilație 환풍기
- Raccoglitore  Каплесборник
Συλλέκτης σταγόνων Damlama tepsi
Odkapní miska 接水盤
Ociekacz ドレンパン
Colector picături 물받이
- Messaggio  Сообщения
Μηνύματα Mesajlar
Zprávy 信息
Wiadomości 메ッセ지
Mesaje 메세지



**/// BRAVILOR
BONAMAT**

© 05-2010

700.403.564B